



# Design for Accessibility

A Cultural Administrator's Handbook

## Civil Rights for People with Disabilities: Framing the Discussion

No discussion on accessibility is complete without understanding the history of accessibility as a civil right. The Americans with Disabilities Act of 1990 and the Rehabilitation Act of 1973 are significant laws in the United States' long history of enacting legislation to ensure the civil rights of its people. The concept of civil rights in this country began with the signing of the Declaration of Independence. Unfortunately, "We hold these truths to be self-evident, that all men are created equal, that they are endowed by their Creator with certain unalienable Rights, that among these are Life, Liberty and the Pursuit of Happiness," although promising in sentiment, did not provide specifics. Hence, the disability rights movement, although relatively new, vividly brings the needs, concerns and rights of people with disabilities to national attention.

**1776:** The Declaration of Independence states "all men are created equal."

**1865:** The Thirteenth Amendment to the Constitution abolishes slavery.

**1868:** The Fourteenth Amendment holds that no state can deny any U.S. citizen equal protection under the law.

**1920:** The Nineteenth Amendment grants women the right to vote.

**1935:** The League of the Physically Handicapped, New York City, protests discrimination against people with disabilities by federal relief programs with sit-ins, picket lines and demonstrations.

**1964:** The Civil Rights Act of 1964 prohibits employment discrimination based on race, sex, national origin or religion, and prohibits public access discrimination.

**1967:** The Age Discrimination in Employment Act (ADEA) prohibits age discrimination for 40 to 65-year-olds. In 1986, it is amended to remove the 65-year-old age cap.

**1968:** The Architectural Barriers Act mandates that federally constructed buildings and facilities be accessible to people with physical disabilities.

**1970:** Disabled in Action organizes, after a successful employment discrimination suit against New York City's public school system, and files litigation on behalf of disability rights in several cities.

**1971:** The U.S. District Court of Alabama, in a crucial victory for de-institutionalization, rules that people with disabilities cannot be locked away in "custodial institutions" without treatment or education.

**1971:** Disabled activists in Washington, DC demonstrate to protest the Presidential veto of what will become the Rehabilitation Act.

*Continued on inside back cover*

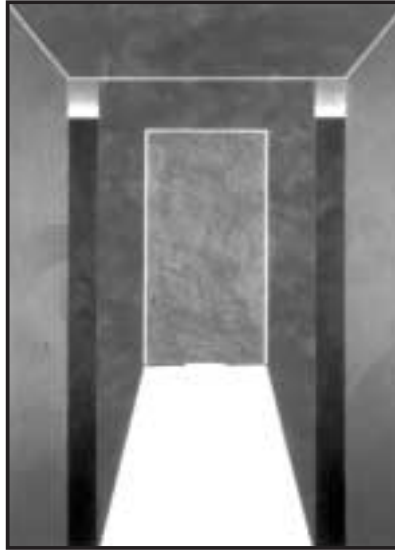

# Design for Accessibility

A CULTURAL ADMINISTRATOR'S HANDBOOK



NATIONAL  
ENDOWMENT  
FOR THE  
HUMANITIES

National Assembly of  
State Arts Agencies  
KNOWLEDGE \* REPRESENTATION \* COMMUNITY

The Kennedy Center

**MetLife Foundation**

## Cover Artwork

Alex Wilhite, "Illusion of Red & Blue," 1988, acrylic on canvas, 38 x 28 inches. Courtesy of VSA arts Gallery, ©Alex Wilhite, 1994. Postminimalist Alex Wilhite's large-scale works are boldly abstract, geometrically precise and typically characterized by bright, strong colors. He makes his own paint from earth materials and uses acid-free paper, canvas and wood. Wilhite is a graduate of the Pratt Institute in Brooklyn, New York, and his work has been shown throughout the United States and Europe.

### **Order Information**

Print copies of “Design for Accessibility: A Cultural Administrator’s Handbook” may be obtained by contacting:

National Assembly of State Arts Agencies (NASAA)  
1029 Vermont Avenue, NW, 2nd Floor  
Washington, DC 20005  
(202) 347-6352 voice  
(202) 347-5948 TTY  
(202) 737-0526 fax

 Individuals who do not use conventional print may access this publication on the Arts Endowment Web site at [www.arts.gov](http://www.arts.gov) or contact its AccessAbility Office for help in acquiring an audio recording of this book:

National Endowment for the Arts  
Office for AccessAbility  
1100 Pennsylvania Avenue, NW  
Washington, D.C. 20506-0001  
(202) 682-5532 voice  
(202) 682-5496 TTY  
(202) 682-5715 fax

### **Disclaimer**

The information presented in this handbook is intended solely as guidance and is neither a determination of an organization’s legal rights and responsibilities under Section 504 of the Rehabilitation Act of 1973, as amended; the Americans with Disabilities Act (ADA), or any of the laws referenced herein, nor binding on any agency with enforcement responsibilities under Section 504 or the ADA. It is not intended to and may not be relied upon to create any right or benefit, substantive or procedural, enforceable at law by a party against the United States.

© NASAA. All rights reserved.

### **A Message from MetLife Foundation**

**Ten years ago MetLife Foundation partnered with the National Endowment for the Arts and the National Assembly of State Arts Agencies in the development and publication of “Design for Accessibility: An Arts Administrator’s Guide.” We are pleased to be part of this latest effort to sponsor “Design for Accessibility: A Cultural Administrator’s Handbook.” Making cultural facilities and programs more accessible for people of all abilities is an integral part of MetLife Foundation’s commitment to inclusion. Working together, we can make a difference.**

## FOREWORD

Every person in America, including the 54 million citizens with disabilities and more than 35 million Americans who are age 65 and older, should be able to participate in the arts and the humanities. Cultural communities across the country are focusing on inclusion: integrating older adults and people with disabilities into all aspects of the organization—from planning and design to marketing and technical assistance.

The National Assembly of State Arts Agencies (NASAA), the John F. Kennedy Center for the Performing Arts, the National Endowment for the Humanities and the National Endowment for the Arts are committed to fully accessible programming. Accessibility, however, must ultimately become everyone's responsibility to make a lasting difference, and it is organizations and individuals in the field who are making it happen.

"Design for Accessibility: A Cultural Administrator's Handbook" represents an update of the Arts Endowment's "The Arts and 504" (1992) with additional information from the 700-page "Design for Accessibility: An Arts Administrator's Guide" produced by the Arts Endowment and NASAA in 1994. This resource is designed to help you not only comply with Section 504 and the Americans with Disabilities Act, but to assist you in making access an integral part of your organization's planning, mission, programs, outreach, meetings, budget and staffing.

In the new millennium, inclusion must be ever present in our vision. As new technologies and methods are developed, the possibilities of access will change. Since the disability rights movement rose to prominence in the 1970s, federal legislation has been passed, and disabled individuals are finally becoming part of the cultural mainstream. Great strides have been made, particularly in architectural and program access. Many Americans with disabilities now have the opportunity to create and participate fully in the arts and humanities. Much work, however, remains to be done. We hope this handbook will assist you with that important work.



Dana Gioia, Chairman  
National Endowment for the Arts

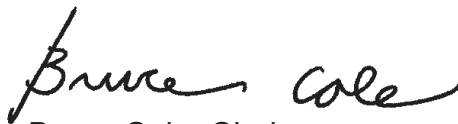

Bruce Cole, Chairman  
National Endowment for the Humanities



Jonathan Katz, Chief  
Executive Officer, National  
Assembly of State Arts Agencies



Derek E. Gordon, Senior  
Vice President, John F. Kennedy  
Center for the Performing Arts

## Goal of This Handbook

The goal of “Design for Accessibility: A Cultural Administrator’s Handbook” is to provide guidance to cultural administrators on accessibility and inclusion for creating new or opening up existing programs to include individuals with disabilities and older adults, whether as staff, volunteers, program participants or audience members.

“Design for Accessibility: A Cultural Administrator’s Handbook” addresses several key points:

- Cultural programs must be fully accessible and inclusive to every individual, including citizens with disabilities and older adults.
- Cultural service organizations need to set an example for their constituents by making their facilities, meetings, Web sites, print materials and activities fully accessible and inclusive to everyone.
- The assurance of equal opportunity for all people to participate in the humanities and the arts should be a fundamental starting point.

This handbook offers introductory guidance on how to accomplish these goals. More information about accessibility may be found under “Accessibility” at the National Endowment for the Arts’ Web site, [www.arts.gov](http://www.arts.gov), the National Endowment for the Humanities Web site, [www.neh.gov](http://www.neh.gov), and by contacting organizations listed in the resource pages at the end of each chapter.

**“We are advocates for full access to the arts. All arts organizations should be physically and programmatically accessible to all people with disabilities, artists and audiences alike. If these organizations provide anything less, they are breaking laws that have been in existence for thirty years.”**

Margaret Staton, Founder/Chair, and Deborah Lewis, Executive Director,  
The Ethel Louise Armstrong Foundation

# Table of Contents

<b>Foreword</b> .....	<b>1</b>
<b>The Goal of this Handbook</b> .....	<b>2</b>
<b>Chapter 1</b> Planning with Inclusion as the Goal .....	<b>5</b>
Key Planning Points for Cultural Organizations .....	6
Objectives and Strategies .....	7
Planning and Partnership Questions .....	8
<b>Chapter 2</b> Legal Overview: the ADA and the Rehabilitation Act .....	<b>15</b>
Introduction .....	15
The Laws and Guidelines .....	16
Key Requirements and Best Practices .....	23
Definitions .....	30
Americans with Disabilities Act Questions and Answers .....	32
<b>Chapter 3</b> Architectural Access .....	<b>55</b>
Universal Design .....	55
Surveying for Accessibility .....	59
Preliminary Guide to Architectural Accessibility .....	62
<b>Chapter 4</b> Architectural Access to Historic Properties .....	<b>87</b>
Planning Accessibility Modifications .....	88
Making Historic Landscapes Accessible .....	92
<b>Chapter 5</b> Effective Communication and Program Access .....	<b>97</b>
For People who are Blind or Have Low Vision .....	98
For People with Hearing or Speech Disabilities .....	102
For People with Cognitive Disabilities .....	108
<b>Chapter 6</b> Accessibility in Arts and Humanities Activities .....	<b>115</b>
Museums, Exhibitions and Visual Arts .....	117
The Performing Arts .....	121
Multimedia: Film, Video, Radio, Television, Web sites and the Internet .....	127
Literary Activities .....	130
<b>Chapter 7</b> Meetings, Panels, Lectures and Conferences .....	<b>137</b>
Accessible Presentations .....	139
<b>Chapter 8</b> Training for Staff, Board Members, Volunteers and Constituents .....	<b>145</b>
Components of an Effective Training Program .....	146
Producing an Accessibility Conference or Workshop .....	149
<b>Chapter 9</b> Audience Development and Marketing .....	<b>155</b>
Invite, Welcome and Respect .....	155
Basic Strategies and Tools for Marketing Accessibility .....	156
Targeting a Specific Population or Group .....	157
Useful Tools .....	158
<b>Chapter 10</b> Accessibility is a Work in Progress .....	<b>163</b>



photo by William Frederling

Dance Detour, Chicago, IL: Alana Yvonne Wallace, Maria Lainer and Heather Baumgarner



# Planning With Inclusion as the Goal

In the year 2003, more than 54 million Americans live with disabilities. Because of advances in medical science, the number of people surviving disabling accidents and conditions has grown and the proportion of people with disabilities in American society is increasing. As a result of federal legislation focusing on education, employment, and access to public and private services and facilities, people with disabilities are increasingly becoming an economic force, as well as gaining access to the cultural mainstream.

Further, 37 million Americans are age 65 or older. By the year 2030, the Census Bureau estimates that one out of four people will be over the age of 65. The profile of older adults is changing. People over 65 are healthier, work longer, are more interested in volunteer opportunities and have more resources than in previous generations. Increasingly, they will be more involved in recreational and cultural activities. Cultural organizations must plan for inclusion by providing fully accessible spaces and programs that welcome people of all ages and abilities.

As these demographic changes take place, the concept of universal design in architecture has provided a new way of thinking about inclusion. The goal of universal design is to make the human environment usable by as many people as possible.

Cultural organizations and agencies must move beyond old concepts that define people with disabilities and older adults as a “special” group of people. The focus of cultural organizations needs to shift to a policy of

**“State arts agencies have the opportunity to change the way their grantees think about the ADA. They can help their constituents embrace and not fear what the program is about. It is a work in progress—and not meant to be done tomorrow. Why do it? Because it is the right thing to do. The arts are for everyone.”**

Wayne Lawson, Executive Director, Ohio State Arts Council

inclusion, a way of ensuring that people with disabilities and older adults have the same opportunities as other participants. Accessibility leads to inclusion and should be viewed as an organizational asset that creates a larger audience by engaging everyone in the arts and humanities. Older adults and people with disabilities will patronize organizations where they feel comfortable and welcomed.

## **Key Planning Points for Cultural Organizations**

- Accessibility is an organizational asset.
- Access is a civil rights issue. Access to cultural programs is a legal requirement of the Americans with Disabilities Act and Section 504 of the Rehabilitation Act. State humanities councils and state arts agencies receiving federal funding need to understand these legal requirements.
- Involve people with disabilities and people of all ages throughout the accessibility planning process by establishing an access advisory committee.
- Include people with disabilities in the organization's definition of diversity.
- Plan for the inclusion of people with disabilities and people of all ages as an integral part of long-range or strategic plans.
- Articulate inclusiveness in value statements, goals and program strategies.
- Be a leader. Broker new partnerships; facilitate learning experiences and reward excellence.
- Include individuals with disabilities as staff, board members and volunteers.
- Remember that accessibility is only one means to a larger goal— inclusion in the cultural community of people of all ages, with and without disabilities.

**“To be creative in later life provides an invaluable model of what is possible as we age, for our children, grandchildren, great grandchildren and society. As a role model in your family or in the lives of others, you can shape individual thinking and societal policies about aging. Historically, creativity has distinguished elders as “keepers” of the culture, those who pass the history and values of family and community on to the next generation...most important, aging and creativity present an unparalleled opportunity for us as individuals, to grow as we grow older, in ways that in younger years we could not even have dreamed.”**

“The Creative Age” by Gene D. Cohen, M.D., PH.D., Avon Books, Inc., 2000

## Objectives and Strategies

When developing a plan to achieve accessibility and inclusion, an organization should define its direct internal and external objectives, including:

- Thorough review of procedures and means of interacting with constituents.
- Appointment of an accessibility coordinator.
- Accessibility of buildings and grounds.
- Accessibility of public meetings.
- Design of print materials for legibility and easy comprehension.
- Accessibility of Web site for use by people with hearing, mobility and visual disabilities.
- Accessibility of other communication systems.
- Programming respectful and reflective of the community.

Indirect objectives for promoting accessibility and inclusion may involve:

- Educating constituents about their legal obligations and effective ways to achieve accessible programs and activities.
- Providing technical aid to constituents to remove physical barriers.
- Serving as an information resource and model of accessibility.
- Assessing the economic impact of audience expansion on cultural programming.
- Creating partnerships that promote inclusion and access.

**“In order for a state agency to have a commitment to ADA, the ground work must be done by the 504/ADA coordinator. The coordinator must ensure that staff and board are educated and continuously updated regarding issues of compliance. The Ohio Arts Council’s access work includes: mandating that at least one person with a disability serve on every panel; establishing a statewide network of artists with disabilities; and professional development grants to assist their careers. None of this would have been possible without our Access Advisory Committee of artists with disabilities, keeping staff and board aware of access issues, and, most important, the strong and steadfast support of our Executive Director and our Board.”**

Phyllis Hairston, Building Diverse Audiences & 504/ADA Coordinator,  
Ohio Arts Council

## Planning and Partnership Questions

No single strategy or plan is right for every cultural organization. A plan should be tailored to meet the needs of an organization's existing and future constituencies. The best way to do this is by including people with disabilities and people of all ages in the planning process. The following questions can help clarify what strategies are appropriate for your organization.

**Q.** For grant making organizations, such as state humanities councils and state arts agencies, what is the organization's commitment to ensuring that people with disabilities and people of all ages have access to the cultural activities within their area?

**A.** An organization should work with staff and representatives from the field to:

- Provide technical assistance to applicants and grantees.
- Ask grantees to document their accessibility efforts or assessments.
- Include accessible language in grant making criteria and application forms.
- Fund accessibility projects as part of audience expansion, technology programs and inclusiveness initiatives.
- Establish a complaint procedure.

**Q.** How can a cultural organization work together with its constituency to make cultural resources more inclusive and accessible to everyone?

**A.** Many tools exist to aid this discussion. The organization can send a questionnaire to the field to elicit the accessibility achievements and needs of constituents. It can hold strategic planning forums that include participants from other cultural organizations and from the disability community. The most useful tool is the creation of an ongoing advisory committee that includes people, with and without disabilities, who, along with staff and board members, help to develop the inclusive aspects of the organization's strategic plan. It is also important to have people with disabilities on review panels, on staff and on the board of directors.

**Q.** What are some strategies a cultural organization can use to help constituents achieve more inclusive environments?

**A.** In addition to funding, the organization can provide information and technical assistance with assessment, development and execution of accessibility plans. It can offer access workshops and include accessibility on the agenda at statewide or regional cultural conferences. It can make

accessibility resources available in print material, electronic postings of access resources on the organization's Web site and find ways for other groups with good track records to share their success stories.

Remember that many nonprofit organizations, as well as state and federal agencies dealing with disability and accessibility issues, may also provide information and services.

**Q.** How can a cultural organization promote partnerships?

**A.** A cultural organization, particularly a regional, state or local arts agency or state humanities council, knows its constituency and is familiar with other cultural organizations in its area. It can work to promote partnerships between complementary organizations. Strategies might include sharing the cost of equipment, promoting joint fundraising projects and producing cultural access guides. An organization may encourage constituents to form partnerships with private foundations and corporations to provide services, products or funding. An organization may also acknowledge its constituents' successes through awards, in "best practices" publications and feature articles, or on Web sites.

**Q.** What are the steps in planning for an accessible environment?

**A.** The first step in the planning process is making the commitment to accessibility. Assessing the organization's current accessibility assets and planning for what it needs should follow. Finally, an organization should advertise its accessibility assets to its constituents.

**Q.** How does a cultural organization evaluate its accessibility assets?

**A.** Chart what accessibility assets the organization has and what assets it needs to meet or exceed legal standards. Look at the buildings, grounds, programming, how meetings are conducted and communications systems.

**"We at the Arts Endowment believe that it is important to listen to and celebrate the diverse voices of America, to literally hear and see all America singing and talking and painting and writing. Through lessons gleaned from the challenges of everyday life, Americans with disabilities have an important contribution to make to our democracy. We need to challenge America's sense of ease and entitlement, and demand that our nation open the doors of our cultural institutions so that people with disabilities may contribute their vision and craft to our country's journey through the rich and complex landscape of the 21st century."**

William Ivey, Chairman, National Endowment for the Arts (1998-2001)

Examine procedures for interaction with employees, volunteers, program participants and audience members. The assessment should involve staff, the board of directors, outside consultants, the accessibility advisory committee, audience members and program participants.

Strategies should be developed to obtain needed accessibility assets as part of the overall strategic plan. An organization must determine:

- Who will be involved in implementing the plan and what their roles will be.
- What outside professional help will be needed.
- What it will cost to implement the plan.
- How the work will be funded.
- Whether the work will be done all at once or in stages.

**Q.** How does an organization use its accessibility assets to attract new audiences?

**A.** All too often organizations do substantial work to achieve inclusiveness but neglect to tell anyone about it. An important part of the planning process is to evaluate the organization's current marketing plan to see that it promotes the organization's accessibility assets, and to assure that its marketing tools reach people with various disabilities.

**Q.** When does the planning process end?

**A.** Planning is an organizational tool. Although a particular plan ends when the objectives and goals are reached (or a determination is made that they cannot be reached), the planning process never ends. Access issues, in particular, need ongoing attention. A permanent accessibility advisory committee can help keep the organization on track. A sound organization uses planning as a way to keep the objectives and goals of the organization balanced and to evaluate how well its mission is being met.

## RESOURCES

### Planning for Accessibility

#### **“A State Arts Agency Strategic Planning Tool Kit”**

Published in 2000 by the National Assembly of State Arts Agencies (NASAA) with advice and funding from the National Endowment for the Arts (NEA), the tool kit explores the conceptual basis of planning, outlines the process to use in creating a good strategic plan and includes case studies.

National Assembly of State Arts Agencies (NASAA)

1029 Vermont Avenue, NW, 2nd Floor

Washington, DC 20005

(202) 347-6352 voice

(202) 347-5948 TTY

(202) 737-0526 fax

[www.nasaa-arts.org](http://www.nasaa-arts.org)

#### **“A Universal Environment: Beyond Access to Opportunity”**

The New York State Council on the Arts (NYSCA) created this useful resource for accessibility planning. Please contact NYSCA to request a PDF copy.

New York State Council on the Arts

175 Varick Street

New York, NY 10014

(212) 627-4455 voice

[www.nysca.org/public/resources/access.htm](http://www.nysca.org/public/resources/access.htm)

#### **The Office for AccessAbility of the National Endowment for the Arts (NEA)**

The NEA Office for AccessAbility, established in 1976, is the Endowment’s advocacy/technical assistance arm for people with disabilities, older adults, veterans and people living in institutions. Work includes:

- Providing technical assistance to staff and grantees on making the arts fully accessible and compliant with the Endowment’s Section 504 regulations and the Americans with Disabilities Act (ADA).
- Initiating cooperative projects and leadership initiatives with other federal agencies and nonprofit groups to educate professionals concerning accessibility issues.
- Encouraging support for the needs of older adults, individuals with disabilities and people living in institutions. Planning With Inclusion as the Goal 11

- Assisting applicants and grantees with project development involving targeted groups.
- Organizing and presenting panels, seminars and workshops for NEA staff, grantees and other federal agencies.

National Endowment for the Arts

Office for AccessAbility

1100 Pennsylvania Avenue, NW

Washington, DC 20506

(202) 682-5532 voice

(202) 682-5496 TTY

(202) 682-5715 fax

[www.arts.endow.gov/resources/Accessibility/index.html](http://www.arts.endow.gov/resources/Accessibility/index.html)

## Statistical Information

### U.S. Census Bureau Statistics

The United States Bureau of the Census is the official resource for social, demographic and economic statistics. They also provide data on disability.

Disability Statistics (1997)

- Nearly 1 in 5 people—54 million—said they have some level of disability, while 1 in 8—33 million—report they have a severe disability.
- Among the population aged 15 and over, 25 million have difficulty walking a quarter of a mile or climbing a flight of 10 stairs, or have to use an ambulatory aid.
- 2.2 million are wheelchair users.
- 6.4 million use canes, crutches or walkers. 16.4 million have other mobility impairments.
- 18 million have difficulty lifting and carrying a 10-pound bag of groceries or grasping small objects.
- 7.7 million people have trouble seeing the words and letters in ordinary newspaper print (even with glasses).
- 8 million people have difficulty hearing or are deaf.
- 14.3 million have a mental disability, including 3.5 million with a learning disability.

U.S. Census Bureau

Washington, DC 20233

[www.census.gov/hhes/www/disability/disability.html](http://www.census.gov/hhes/www/disability/disability.html)







photo by Marissa Roth

Smithsonian Institution, Washington, DC: Visitor Freddie Pecco with tactile and braille map

# Legal Overview: the ADA and the Rehabilitation Act

## Introduction

This chapter provides cultural administrators with an overview of the general legal principles used to achieve accessibility for persons with disabilities. Three key federal accessibility laws require all organizations that serve the public or receive direct or indirect federal funds to enable people with disabilities to enjoy the benefits of the organization's services.

Cultural organizations must ensure that these laws are upheld both within their own organization and by any subgrantee or subcontractor receiving federal funding. For example, a state arts agency or humanities organization's enforcement responsibility would include: providing technical assistance; establishing a complaint procedure; investigating any complaints; and, in the instance of a violation, terminating funds and, if appropriate, referring the complaint for further enforcement.

**“The disability rights movement, over the last couple of decades, has made the injustices faced by people with disabilities visible to the American public and to politicians. This required reversing the centuries-long history of ‘out of sight, out of mind’ that the segregation of disabled people served to promote.**

**The disability movement adopted many of the strategies of the civil rights movement before it. Like the African-Americans who sat in at segregated lunch counters and refused to move to the back of the bus, people with disabilities sat in federal buildings, obstructed the movement of inaccessible buses and marched through the streets to protest injustice. And like the civil rights movements before it, the disability rights movement sought justice in the courts and in the halls of Congress.”**

“The History of the ADA: A Movement Perspective,” by Arlene Mayerson, 1992, legal counsel for Disability Rights Education and Defense Fund (DREDF), [www.dredf.org](http://www.dredf.org)

Three pieces of federal legislation have had a significant impact on cultural organizations: the Architectural Barriers Act of 1968, the Rehabilitation Act of 1973, as amended, and the Americans with Disabilities Act of 1990.

This chapter outlines the three federal laws and their implementing standards, and discusses some of the key legal requirements and best practices that maximize inclusion and opportunities for compliance with the laws while minimizing risks.

## **Law and Guidelines**

### **Architectural Barriers Act of 1968 (“ABA”)** (42 U.S.C. § 4151 et seq.)

**Cultural organizations that use federal funds to design, construct or alter a building must comply with a minimum level of physical accessibility.**

The Architectural Barriers Act applies to buildings constructed or altered by, on behalf of, or for the use of the federal government, to federal leases and to buildings:

- to be financed in whole or in part by a grant or a loan made by the United States after August 12, 1968, if such building or facility is subject to standards for design, construction or alteration issued under authority or the law authorizing such grant or loan; or
- to be constructed under authority of the National Capital Transportation Act of 1965, or title III of the Washington Metropolitan Area Transit Regulation Compact.

Other buildings or facilities constructed by recipients of federal funds are subject to Section 504 of the Rehabilitation Act, which requires all new construction and alterations to be accessible. Regulations implementing Section 504 “deem” compliance with the Uniform Federal Accessibility Standards (UFAS) to be in compliance with Section 504. Both statutes require accessible construction, so the compliance obligation for new construction is the same.

ABA requirements do not address the activities or programs conducted in those buildings and facilities.

**Rehabilitation Act of 1973, as amended**  
**(“Rehabilitation Act”)**  
(29 U.S.C. § 794 for Section 504)

**Cultural organizations, private or public, that receive direct or indirect federal funds or federal financial support must make programs, services and activities accessible, including employment opportunities.**

The Rehabilitation Act prohibits discrimination on the basis of disability in programs conducted by federal agencies, in federal employment, in the employment practices of federal contractors and in programs receiving federal financial assistance, including state and local governments and private entities.

The Rehabilitation Act contains five sections that address different aspects of equal opportunity for people with disabilities. In summary, the sections and their requirements are:

**Section 501.** Prohibits discrimination on the basis of disability in the federal government and requires affirmative action in the hiring of people with disabilities by government agencies.

**Section 502.** Establishes the Architectural and Transportation Barriers Compliance Board and gives the board authority to enforce the Architectural Barriers Act of 1968.

**Section 503.** Prohibits employment discrimination by federal contractors and requires anyone receiving a contract or subcontract from the federal government in excess of \$10,000 to have an affirmative action plan for hiring qualified people with disabilities.

**Section 504.** Prohibits discrimination on the basis of disability and requires federal agencies and any organization that receives federal funding to make its programs and activities accessible to people with disabilities.

**Section 508.** Revised in 1998, requires that any electronic or information technology developed, maintained, procured or used by federal agencies be accessible and usable by federal employees and members of the public with disabilities seeking information or services from federal agencies.

Federal agencies each have their own section 504 regulations and cultural organizations (private and public) must comply with the Section 504 regulations of all agencies providing them with federal funds, whether

directly or indirectly. For example, a museum that receives funding from the U.S. Department of Education (direct), and funding from their state humanities council, which received funding from the National Endowment for the Humanities (indirect), must comply with both federal agencies' Section 504 regulations.

Indirect federal financial support includes pass-through money and subgrants. The funds may come from the state or local government, arts or humanities council, but that organization is actually passing on federal funds. For example, when:

- a state arts agency dispenses federal funds from the National Endowment for the Arts (NEA);
- a state humanities council dispenses funds from the National Endowment for the Humanities (NEH);
- a state department of education dispenses funds from the United States Department of Education;
- a state arts council dispenses NEA funds to a local arts agency, which in turn subgrants them to a nonprofit organization; or
- local governments use federal revenue-sharing funds to support arts and humanities programs,

then, in each case, the ultimate fund recipient must comply with the dispensing agency's Section 504 regulations.

### **The Americans with Disabilities Act of 1990 (“ADA”)** (42 U.S.C. § 12101 et seq.)

**Cultural organizations, regardless of whether they receive federal financial assistance and whether they are public or private entities, must not discriminate against individuals with disabilities. Any public or private organization that meets the definition of a covered entity as contained in the ADA must comply.**

In 1990, Congress enacted legislation to expand the civil rights of all individuals with disabilities. The ADA is more sweeping in its coverage than Section 504. It goes well beyond federally funded organizations to encompass private sector entities that serve the public, including cultural organizations that do not receive federal financial support. The ADA prohibits discrimination on the basis of disability in employment, state and local government services, public accommodations, commercial facilities, transportation and telecommunications.

The ADA contains five titles that extend different aspects of equal opportunity for people with disabilities. The titles and their requirements are:

**Title I—Employment.** Requires all employers with 15 or more employees to provide qualified individuals with disabilities an equal opportunity to benefit from the full range of employment-related opportunities available to others.

**Title II—State and Local Government.** Requires that all state and local governments (their departments and agencies) give people with disabilities an equal opportunity to benefit from all of their public programs, activities and services (e.g., public education, employment, transportation, recreation, health care, social services, courts, voting and town meetings).

**Title III—Public Accommodations and Services Operated by Private Organizations.** Requires places of public accommodation to meet architectural accessibility standards for new and altered buildings and remove barriers in existing buildings where such removal is readily achievable; make reasonable modifications to policies, practices and procedures; provide effective communication mechanisms for people with hearing, vision or speech disabilities; and other access requirements.

**Title IV—Telecommunications.** Amends the Communications Act of 1934 to require common carriers (telephone companies) to provide interstate and intrastate Telecommunications Relay Services (TRS) 24 hours a day, 7 days a week. This title addresses captioning of public service announcements. (Captioning and video description of television programming are addressed in later statutes and in regulations issued by the Federal Communications Commission.)

**Title V—Miscellaneous Provisions.** States, among other provisions, that federal laws shall not supersede state laws with more stringent accessibility provisions.

## **Federal Accessibility Standards**

Federal law requires that organizations adhere to physical accessibility standards to comply with the three laws described above. The U.S. Architectural and Transportation Barriers Compliance Board (Access Board) is responsible for developing accessibility guidelines to assist federal standard-setting agencies to implement the Architectural Barriers Act

of 1968 (ABA) and the Americans with Disabilities Act of 1991 (ADA). The Access Board has published two sets of guidelines:

- The Minimum Guidelines and Requirements for Accessible Design were used as the basis for the Uniform Federal Accessibility Standards (UFAS) published by the General Services Administration, Department of Housing and Urban Development, U.S. Postal Service and the Department of Defense under the ABA.
- The ADA Accessibility Guidelines (ADAAG) form the basis of the accessibility standards published by the Department of Justice and the Department of Transportation to implement the ADA.

In 1999, the Access Board began updating and revising both standards in order to make them more consistent with one another. These standards will contain the minimum requirements necessary for compliance with the ABA, Section 504 and the ADA, and should be completed by 2003.

In general, private nonprofit and for profit cultural organizations (places of public accommodation) are subject to the ADA Standards including the ADAAG. Federal agencies, public cultural organizations (state or local government agencies) and private organizations receiving direct or indirect federal funds are subject to UFAS. This includes the National Endowment for the Humanities (NEH) and the National Endowment for the Arts (NEA). Under Title II of the ADA, as will be discussed, in certain circumstances public cultural agencies not receiving federal funding may have a choice between standards. Neither the ADA Standards including the ADAAG nor UFAS supersede state or local laws that provide greater or equal benefit to individuals with disabilities.

Cultural organizations that fall under more than one of these mandatory standards should follow the requirement that provides the greatest level of accessibility.

### **Administrative Requirements of Section 504 and Title II of the ADA**

Congress passes laws and then directs various federal agencies to develop regulations that are used as the tools by which the agencies enforce the laws. For example, Congress passed the Rehabilitation Act and directed each federal agency to develop its own set of Section 504 regulations to implement agency programs. Congress passed the Americans with Disabilities Act and directed the Equal Employment Opportunity Commission (EEOC) to develop the regulations for Title I and the Department of Justice (DOJ) and Department of Transportation to develop the regulations and accessibility standards for Titles II and III.



Federal agencies each have their own Section 504 regulations. Organizations receiving federal funding should determine what the Section 504 requirements are for each agency from which it receives funding. The National Endowment for the Humanities (NEH) and the National Endowment for the Arts (NEA) amended their Section 504 regulations in 1991 to require that their grantees follow UFAS. If the grantee is also a place of public accommodation, it is also subject to Title III of the ADA, which requires compliance with the Title III regulations and ADA Standards.

There are a number of administrative requirements outlined in most Section 504 regulations and/or in Title II of the ADA. Five key requirements are highlighted below. Many state agencies and cultural organizations that receive federal funding have already met these requirements. If an organization has not taken these steps, it should do so immediately.

1. Appoint a staff member as the ADA/504 coordinator (or accessibility coordinator) to coordinate the organization's ADA/504 obligations.
2. Provide public notice of events and activities that indicate the organization will comply with the Rehabilitation Act and the ADA.
3. Establish internal grievance procedures for individuals with disabilities.
4. Conduct a self-evaluation of all policies, practices and programs to determine if they are equally available to people with and without disabilities.
5. Develop a transition plan to identify what structural or physical changes should be made to achieve program access, and a time frame for implementation.

## State Law

State and local laws may affect cultural organizations and must be checked individually since they vary from state to state. There are two types of state and local laws that may have an impact on accessibility issues for cultural organizations:

- Nondiscrimination laws may cover smaller cultural organizations not covered by federal law and may impose stricter standards than federal

**“I’m always surprised by discrimination in the creative community. When a director says, ‘I don’t know how to use you’, an educator says, ‘I can’t see a way to let you participate with the group’, or a facilities coordinator says, ‘We weren’t able to make this event accessible’; it still catches me off-guard. I believe that truly creative people don’t discriminate because they are able to see the possibilities and potential in all people and in all situations.”**

Cindy Brown, ARTability: Accessing Arizona’s Arts, Phoenix, AZ

law. State and local laws may also permit lawsuits providing the successful party specific relief such as accommodations (e.g., assistive listening systems for individuals with hearing-loss or more integrated seating options for people who use wheelchairs and/or other mobility aids), as well as damages and the recovery of legal fees.

- Building Codes may contain technical provisions related to construction, renovations and alterations. Cultural organizations must comply with building codes when they obtain building permits and certificates of occupancy.

## **Enforcement and Complaint Procedures**

There are consequences for noncompliance with access laws. Honest good faith efforts to comply with access laws and the treatment of all people with equality and dignity can help avoid complaints and lawsuits.

When an organization applies to the NEA, the NEH, or to a local, state or regional arts agency or humanities council, it is required to sign an assurance or certification of compliance with federal nondiscrimination laws, including Section 504 of the Rehabilitation Act and the ADA. Various federal, state, local and regional agencies are responsible for enforcing these requirements.

If an individual believes that an organization has discriminated on the basis of disability under:

- Section 504 - they may file an administrative complaint with the federal or state agency that funded the organization;
- Title I, II, or III of the ADA - they may file a complaint with the designated federal enforcement agency such as the Equal Employment Opportunity Commission or the Department of Justice, or under Titles II and III, they may skip the administrative complaint process and file a private lawsuit.

**“The major issue is accessibility with dignity. It is not enough to get into a building just any old way. I like to get into a building at the front with everybody else, where the rest of the society gets in.”**

Itzhak Perlman, violinist

## Key Requirements and Best Practices

Frequently cultural administrators ask what their organization should do to be in compliance with disability rights laws. The three federal laws addressed in this chapter mandate:

- nondiscrimination;
- equal opportunity (and the provision of any reasonable modifications, auxiliary aids or services necessary to achieve it);
- basic standards of architectural access; and
- equal access to employment, programs, activities, goods and services.

A cultural organization's responsibilities and obligations under the Architectural Barriers Act, Section 504 of the Rehabilitation Act, and Titles I, II and III of the ADA focus on several key requirements. These laws and regulations do not tell organizations how to accomplish these goals. Instead, the laws and regulations have been written to allow as much flexibility as possible. Achieving accessibility and compliance with disability laws is an ongoing process. Good accessibility practices can maximize the opportunity for compliance while minimizing risks. These practices should complement any existing accessibility efforts and planning that cultural organizations have already undertaken.

### 1. Do not discriminate against individuals with disabilities.

**Best Practice:** Make nondiscrimination mandatory. Emphasize to employees, contractors and grantees that compliance with accessibility requirements and nondiscrimination laws is mandatory. Granting agencies commonly require grantees to obtain written assurances to this effect from subgrantees. By emphasizing and highlighting these provisions in all contracts, the institution makes all entities with which it does business aware of the importance of these provisions.

**Best Practice:** Make accessibility and nondiscrimination an integral and routine part of day-to-day operations. Secure leadership and institutional commitments from all employees and volunteers—from the board, executive director and management team, to every administrative, production, design and maintenance person, to volunteer docents and ushers. Make this commitment internally and externally visible.

**“Nothing about us without us. We are looking for programs that are integrated, but in which we have real power. This is not art for us, this is art by us.”**

Victoria Ann Lewis, founder and co-director of Other Voices, Mark Taper Forum, Los Angeles, CA

**Best Practice:** Apply accessibility laws to all functions. Understanding that accessibility laws apply to all functions of the organization whether on-site or off-site is essential. This includes performances, exhibits, conferences, panel meetings, grant reviews, fundraisers, special events and staff gatherings—no matter where conducted. If a cultural organization sponsors an off-site event, the alternate site must also be accessible. It is important to visit and evaluate a site before committing to it.

**Best Practice:** Include indemnification provisions in contracts and grants. To maximize protection, include a provision requiring all subgrantees and contractors to fully indemnify the cultural organization in the event of an administrative complaint to a federal, state or local agency or lawsuit related to discrimination or lack of accessibility. Indemnification provisions should include the actual cost of the award, court costs, legal fees and the cost of professional experts, as well as the time of the cultural organization's staff and board of directors.

## **2. Provide individuals with disabilities with effective communication mechanisms and an equal opportunity to benefit from programs, activities, goods and services.**

Section 504 and the ADA, and their implementing regulations, are minimum legal requirements. They are intended to provide people with disabilities an equal opportunity to participate in programs, activities, goods and services in an integrated setting. Programs include activities that a cultural organization makes available to the public such as performances, tours, receptions, special events, lectures, seminars, educational programs, workshops, residencies, exhibitions and conferences.

With rare exceptions, Section 504, and Titles II and III of the ADA require that organizations also provide auxiliary aids and services to ensure effective communication with individuals with hearing or vision loss. These may include services such as qualified interpreters, readers and note takers; devices such as assistive listening systems, accessible computers, written materials for individuals with hearing loss, taped text and braille or large print materials for individuals with vision loss; and flexibility in procedures, such as work schedules.

Cultural organizations should be inclusive in all aspects of their activities. They should create new or re-introduce existing programs and activities in which people with disabilities may participate in an integrated and inclusive environment.

**Best Practice:** Appoint a staff member to be the accessibility coordinator for the organization's accessibility efforts. The accessibility coordinator becomes the "in-house" expert for guiding the organization, its board, staff, volunteers and grantees (if applicable) toward inclusion of people with disabilities and compliance with the ADA and Section 504 regulations. However, remember that compliance and accessibility must be everyone's responsibility.

**Best Practice:** Establish an access advisory committee. Seek out and include input and advice from knowledgeable individuals with disabilities representing different segments of the disability community. They can: educate the organization about legal and social issues related to accessibility; evaluate existing programs, policies and facilities; identify areas for improvement; and recommend solutions. Work in partnership with local membership organizations for people with disabilities, parents of disabled children, service agencies, independent living centers, advocacy groups, schools and local government entities, such as vocational rehabilitation and community service boards.

### **3. Remove barriers to existing facilities and assure that all new construction, renovations and alterations meet or exceed applicable federal accessibility standards.**

- **New Construction.** The most rigorous physical accessibility requirements apply to new construction. All new construction of buildings and facilities must meet or exceed the requirements of applicable federal, state and local accessibility standards and codes. These standards and codes set forth minimum standards with which all new construction must comply. Organizations are encouraged to go beyond the minimum standards to achieve the greatest degree of accessibility. For example, an organization might elect to provide more accessible seats than the minimum standards require.
- **Renovations and Alterations.** All renovations and alterations must meet accessibility standards unless to do so is technically infeasible. In that case, they must comply to the maximum extent feasible. If an organization renovates or alters an area in such a way that it affects the

**“A cultural institution and its constituents benefit when farsighted board members and administrators look beyond minimum standards to broaden the potential for usability of space and facilities for all potential staff, constituents, visitors and audiences.”**

Jonathan Katz, Chief Executive Officer, National Assembly of State Arts Agencies

usability of a primary function area, such as the auditorium of a lecture hall or the exhibit space of a museum, then the organization must make the path of travel to that area accessible. For example, if a concert or lecture hall is renovated, the organization must provide an accessible path of travel from the exterior to the altered area, and make the restrooms, telephones and drinking fountains serving the altered area accessible, unless the cost of these modifications are disproportionate to the overall cost of the alterations.

- **Barrier removal.** The federal standards for barrier removal in existing facilities are somewhat more flexible. Section 504 and Title II require modifications only if necessary to ensure program access. However, all organizations (public or private) must complete readily achievable barrier removal if a program cannot be made accessible by any other means. Barrier removal might include ramping to an entrance, relocating displays or exhibits to widen an aisle, installing a levered doorknob or moving a plant out of the path of travel.

Accessibility requirements provide independent, dignified access to all aspects of a facility including, but not limited to, parking, entrances, exhibits, programs, classes, performances, work areas, restrooms, elevators, shops and food services. Regardless of any law or regulation with which a cultural organization must comply, the organization facing new construction, alterations or renovations should insist upon the diligent application of accessibility concepts in design and execution. Cultural organizations are encouraged to go beyond the minimum accessibility standards to provide greater levels of accessibility.

**Best Practice:** Budget for accessibility. Generally, expenses fall into two categories: capital costs for new construction, alterations, renovations and removing architectural barriers, and program or operating costs for providing effective communication and auxiliary aids. Anticipate ongoing expenses for capital improvements, and for program costs to continue effective communication and to replenish auxiliary aids. The NEA and the NEH encourage applicants to include in their budget costs for access and accommodations related to the project (i.e. sign interpreters, audio descriptions and captioning).

**“Accessibility does not have to be expensive. Experience has repeatedly shown that accommodations designed to serve people with disabilities generally improve the quality of programs for the broader public. In short, museums cannot afford not to make their programs accessible to all visitors.”**

Janice Majewski, Smithsonian Institution, Washington, DC

**Best Practice:** Hire qualified, knowledgeable professionals. Not all architects, designers, contractors and lawyers are familiar with accessibility requirements. Examine the work of these professionals before making commitments, and ask for references from persons in the disability rights community. Further, work with your advisory committee and/or a local independent living center to review plans and work as the project progresses.

#### **4. Review and modify policies, procedures and practices to prevent discrimination.**

Cultural organizations must make reasonable modifications to policies, procedures and practices that deny equal access to individuals with disabilities unless the changes would result in a fundamental alteration in the program or the nature of the goods and services. An overarching institutional policy that makes a commitment to universal accessibility is an excellent start.

Cultural organizations should carefully examine all policies, procedures and practices with members of the disability community along with staff and board members to determine if they provide equal access or inadvertently discriminate against people with disabilities. This is essential to making programs and facilities accessible. Policies, procedures and practices include a wide range of activities:

- Policies include eligibility criteria, employment guidelines, admission and ticketing rules, and fee structures.
- Procedures are the planned actions by which policies are implemented.
- Practices are the routine ways in which policies and procedures are carried out on a day-to-day basis.

Consider a small museum operating in a historic property. In order to make the museum accessible and preserve the historic nature of the building, the advisory committee has recommended installing a ramp to a side entrance. In the past, the policy has been to keep all doors except the front door locked.

Their new policy states, "Whenever the front door is unlocked, the side entrance must also be unlocked." The new procedure requires maintenance staff to lock and unlock the side entrance at the same time they lock and unlock the front door. In addition, appropriate signage is placed at the inaccessible front entrance directing people to the accessible side entrance and both entrances are open to the general public. In practice, if staff members fail to unlock the side entrance, the museum is not providing equal access because everyone should be able to enter without waiting.

Organizations must not charge additional fees or require persons with disabilities to pay for costs incurred for ADA or Section 504 compliance. This does not mean that people with disabilities must be admitted free if others pay an admission charge. It does mean that if someone requires braille or other accommodations because of a disability, the organization cannot charge extra to provide it. For example, a theater may not charge for the use of assistive listening devices nor may a state arts agency charge to provide a sign language interpreter for a public meeting. These expenses should be considered as overhead and budgeted in advance.

**Best Practice:** Plan for accessibility. Working with your access advisory committee, identify the organization's accessibility assets by carefully evaluating four areas: nondiscrimination obligations (including policies, practices and procedures), facility and program accessibility, communications and employment. Then, develop strategies, plans and timelines for addressing strengths and weaknesses. Organizations should be prepared to respond to requests for effective communication such as captioning, sign language interpretation, braille or large print materials as well as other requests for accommodations. Implementing access does not have to be difficult or expensive. It can be a creative, engaging and instructive process in which the organization's entire staff participates.

**Best Practice:** Address every issue and policy with the question, "Does this provide equal access for everyone?" Equal access means making programs and services as close as possible to being the same for everyone, and that access is functional, safe, convenient and dignified. Access means entering through the primary entrance of a facility, being able to work, to use a facility and to participate fully in programs and activities.

**Best Practice:** Educate and train board members, staff, volunteers, panelists and grantees. Conduct regular training concerning access issues for everyone including board members, staff and constituents (including subgrantees). Your access advisory committee should be involved in planning and conducting the training. Ensure that everyone understands all accessibility accommodations and can properly apply all policies, practices and procedures. Staff should treat everyone,

**"Access is what state arts agencies are all about. We work to develop new audiences, create ways to capture the attention of our young people and support programs that enhance the participation of our state's citizens in the arts. Issues surrounding Section 504, the Americans with Disabilities Act, and access should be at the top of all of our lists. It just makes sense."**

Robert C. Booker, Executive Director, Minnesota State Arts Board



colleagues and visitors alike, with the same dignity and respect that they would wish to be accorded. A thoughtful, courteous attitude indicates that the organization is acting in good faith to meet the needs of people with disabilities.

**Best Practice:** Establish an institutional memory on disability issues and compliance efforts. By tracking what it has done (both good and bad), the organization can avoid costs by not having to “reinvent the wheel” every time a situation arises—whether it is access to a new program, construction/renovation of the facility or employment-related. The accessibility coordinator, the human resources office, the facilities office or the executive director’s office might serve as the institutional policy archivist.

**Best Practice:** Emulate the successful practices of others. Network with other professionals and cultural administrators, find out what works and does not work, and keep abreast of access innovations and accessibility practices. It is perfectly acceptable for cultural entities to incorporate other organizations’ successful practices, giving credit where credit is due.

**Best Practice:** Review accessibility efforts at regular intervals. Routinely review, assess and update the organization’s accessibility plans, programs, policies and practices, in cooperation with the access advisory committee, at regular intervals. Frequent reviews will not only assist the organization in completing its goals, but also will provide a mechanism for revising and updating plans to incorporate fresh ideas, new technologies and other improvements as the organization evolves.

## **5. Provide individuals with equal employment opportunities.**

The employment requirements of the Rehabilitation Act and the ADA are similar. These laws mandate that recipients of federal financial assistance, places of public accommodation, and state and local governments judge applicants solely on the basis of their qualifications.

The ADA’s Title I employment provisions apply to private employers, state and local governments, employment agencies and labor unions with 15 or more employees. Title I and Section 504 require employers to provide qualified individuals with disabilities an equal opportunity to benefit from the full range of employment-related opportunities available to others. For example, the laws prohibit discrimination in recruitment, hiring, promotions, training, pay and social activities; restrict questions about an applicant’s disability before a job offer is made; and require that employers make

reasonable accommodations for the known physical or mental limitations of otherwise qualified individuals with disabilities, unless doing so results in undue hardship to the employer.

Nondiscriminatory employment procedures include making recruitment and job applications accessible. For example, a person who is blind or has low vision may benefit from large print or braille applications, or accessible online applications, and applicants who are deaf or hard of hearing should be offered a sign language interpreter for interviews (if requested in advance). An organization should advertise job openings in multiple media, such as the Internet, radio and print. Employers with job hotlines for applicants must make the hotline accessible to people who are deaf or hard-of-hearing, or provide alternative methods of receiving information. Employers are also required to post notices to all employees advising them of their rights under the ADA and Section 504. Such notices must be accessible to persons with visual or other disabilities that affect reading abilities.

**Best Practice:** Review all personnel policies for compliance with nondiscrimination laws. The organization should adopt appropriate disability-related policies and monitor their application annually as it would all other employment practices. Policies should include, but not be limited to, reviewing position descriptions to ensure they are current, accurate and do not exclude or screen out persons with disabilities; making sure application forms and interviewers do not ask, directly or indirectly, about a disability; establishing a policy on reasonable accommodation; reviewing health insurance and benefit plans to make sure they do not discriminate; keeping medical information confidential; and having physical examinations be job related, consistent with business necessities.

## Definitions

**Grievance procedures** are internal procedures for the resolution of differences between an organization and its staff or users with disabilities.

**A person with a disability** is defined by the ADA and Section 504 of the Rehabilitation Act as someone who has a physical or mental impairment that substantially limits one or more major life activities, a person who has a history or record of such impairment, or a person who is regarded as having such an impairment. Neither the Rehabilitation Act nor the ADA specifically names all of the impairments that are covered.

**Private entities** that operate public accommodations include restaurants, hotels, theaters, convention centers, retail stores, museums, performing arts centers, libraries, parks, zoos, amusement parks and private schools. They are covered under Title III of the ADA.

**Public entities** include any state or local government and any of its departments, agencies or other instrumentalities. They are covered under Title II of the ADA.

**Public notice** is the dissemination of sufficient information to applicants, grantees, participants, beneficiaries, and other interested persons to inform them of the rights and protections afforded by Section 504 and the ADA. Methods of providing public notice include announcements in handbooks, manuals, pamphlets, newsletters, Web sites and application materials.

**A qualified person with a disability** is someone who meets the definition of a person with a disability and meets the legitimate skill, experience, education, or other requirements of an employment position that they hold or seek and who can perform the essential functions of the position with or without reasonable accommodation. A qualified person with a disability in a non-employment context is someone who meets the definition of a person with a disability and meets the essential eligibility requirements for a program, activity, service or benefit offered by a public entity.

**Readily achievable** means easily accomplishable and able to be carried out without much difficulty or expense. What is readily achievable or constitutes a difficulty or expense is determined on a case-by-case basis in light of the resources available. The case-by-case approach takes into account the diversity of enterprises covered by ADA Titles I, II and III and Section 504, as well as the wide variation in the economic health of particular entities at any given moment.

**Reasonable accommodation** is any modification or adjustment to the work environment that will enable a qualified person with a disability to participate in the job application process or to perform essential job functions. In the program setting, a reasonable accommodation may include a reasonable modification to a policy, practice or procedure, provision of an auxiliary aid or service to ensure effective communication, or, under Title III, readily achievable barrier removal.

**Self-evaluation** is the process of evaluating all policies, practices and programs of an organization to ensure equal access and availability to all persons.

**Undue burden** is the standard applied in non-employment situations under Titles II and III of the ADA. The definition of undue burden is the same as the definition of undue hardship, the standard applied in employment situations under Title I of the ADA and Section 504.

**Undue hardship** is defined as an action requiring significant difficulty or expense when considered in light of a number of factors. These factors include the nature and cost of the accommodation in relation to the size, resources, nature and structure of the employer's operation. Undue hardship is determined on a case-by-case basis. In general, larger employers with greater resources would be expected to make accommodations requiring greater effort or expense than would be required of smaller employers with fewer resources. This is the standard under Title I of the ADA and Section 504.

## **Americans with Disabilities Act Questions and Answers**

The following are frequently asked questions and answers about the Americans with Disabilities Act from the U.S. Equal Employment Opportunity Commission and the U.S. Department of Justice Civil Rights Division and can be found at: [www.usdoj.gov/crt/ada/qandaeng.htm](http://www.usdoj.gov/crt/ada/qandaeng.htm)

### **Employment**

**Q.** What employers are covered by title I of the ADA, and when is the coverage effective?

**A.** The title I employment provisions apply to private employers, State and local governments, employment agencies, and labor unions. Employers with 25 or more employees were covered as of July 26, 1992. Employers with 15 or more employees were covered two years later, beginning July 26, 1994.

**Q.** What practices and activities are covered by the employment nondiscrimination requirements?

**A.** The ADA prohibits discrimination in all employment practices, including job application procedures, hiring, firing, advancement, compensation, training, and other terms, conditions, and privileges of employment. It applies to recruitment, advertising, tenure, layoff, leave, fringe benefits, and all other employment-related activities.

**Q.** Who is protected from employment discrimination?

**A.** Employment discrimination is prohibited against "qualified individuals with disabilities." This includes applicants for employment and employees. An individual is considered to have a "disability" if s/he has a physical or mental impairment that substantially limits one or more major life activities, has a record of such an impairment, or is regarded as having such an

impairment. Persons discriminated against because they have a known association or relationship with an individual with a disability also are protected.

The first part of the definition makes clear that the ADA applies to persons who have impairments and that these must substantially limit major life activities such as seeing, hearing, speaking, walking, breathing, performing manual tasks, learning, caring for oneself, and working. An individual with epilepsy, paralysis, HIV infection, AIDS, a substantial hearing or visual impairment, mental retardation, or a specific learning disability is covered, but an individual with a minor, nonchronic condition of short duration, such as a sprain, broken limb, or the flu, generally would not be covered.

The second part of the definition protecting individuals with a record of a disability would cover, for example, a person who has recovered from cancer or mental illness.

The third part of the definition protects individuals who are regarded as having a substantially limiting impairment, even though they may not have such an impairment. For example, this provision would protect a qualified individual with a severe facial disfigurement from being denied employment because an employer feared the “negative reactions” of customers or co-workers.

**Q.** Who is a “qualified individual with a disability?”

**A.** A qualified individual with a disability is a person who meets legitimate skill, experience, education, or other requirements of an employment position that s/he holds or seeks, and who can perform the “essential functions” of the position with or without reasonable accommodation. Requiring the ability to perform “essential” functions assures that an individual with a disability will not be considered unqualified simply because of inability to perform marginal or incidental job functions. If the individual is qualified to perform essential job functions except for limitations caused by a disability, the employer must consider whether the individual could perform these functions with a reasonable accommodation. If a written job description has been prepared in advance of advertising or interviewing applicants for a job, this will be considered as evidence, although not conclusive evidence, of the essential functions of the job.

**Q.** Does an employer have to give preference to a qualified applicant with a disability over other applicants?

**A.** No. An employer is free to select the most qualified applicant available and to make decisions based on reasons unrelated to a disability. For example, suppose two persons apply for a job as a typist and an essential function of the job is to type 75 words per minute accurately. One applicant,

an individual with a disability, who is provided with a reasonable accommodation for a typing test, types 50 words per minute; the other applicant who has no disability accurately types 75 words per minute. The employer can hire the applicant with the higher typing speed, if typing speed is needed for successful performance of the job.

**Q.** What limitations does the ADA impose on medical examinations and inquiries about disability?

**A.** An employer may not ask or require a job applicant to take a medical examination before making a job offer. It cannot make any pre-employment inquiry about a disability or the nature or severity of a disability. An employer may, however, ask questions about the ability to perform specific job functions and may, with certain limitations, ask an individual with a disability to describe or demonstrate how s/he would perform these functions.

An employer may condition a job offer on the satisfactory result of a post-offer medical examination or medical inquiry if this is required of all entering employees in the same job category. A post-offer examination or inquiry does not have to be job-related and consistent with business necessity.

However, if an individual is not hired because a post-offer medical examination or inquiry reveals a disability, the reason(s) for not hiring must be job-related and consistent with business necessity. The employer also must show that no reasonable accommodation was available that would enable the individual to perform the essential job functions, or that accommodation would impose an undue hardship. A post-offer medical examination may disqualify an individual if the employer can demonstrate that the individual would pose a “direct threat” in the workplace (i.e., a significant risk of substantial harm to the health or safety of the individual or others) that cannot be eliminated or reduced below the “direct threat” level through reasonable accommodation. Such a disqualification is job-related and consistent with business necessity. A post-offer medical examination may not disqualify an individual with a disability who is currently able to perform essential job functions because of speculation that the disability may cause a risk of future injury.

After a person starts work, a medical examination or inquiry of an employee must be job-related and consistent with business necessity. Employers may conduct employee medical examinations where there is evidence of a job performance or safety problem, examinations required by other Federal laws, examinations to determine current “fitness” to perform a particular job, and voluntary examinations that are part of employee health programs.

Information from all medical examinations and inquiries must be kept apart from general personnel files as a separate, confidential medical record, available only under limited conditions.

Tests for illegal use of drugs are not medical examinations under the ADA and are not subject to the restrictions of such examinations.

**Q.** When can an employer ask an applicant to “self-identify” as having a disability?

**A.** Federal contractors and subcontractors who are covered by the affirmative action requirements of section 503 of the Rehabilitation Act of 1973 may invite individuals with disabilities to identify themselves on a job application form or by other pre-employment inquiry, to satisfy the section 503 affirmative action requirements. Employers who request such information must observe section 503 requirements regarding the manner in which such information is requested and used, and the procedures for maintaining such information as a separate, confidential record, apart from regular personnel records.

A pre-employment inquiry about a disability is allowed if required by another Federal law or regulation such as those applicable to disabled veterans and veterans of the Vietnam era. Pre-employment inquiries about disabilities may be necessary under such laws to identify applicants or clients with disabilities in order to provide them with required special services.

**Q.** Does the ADA require employers to develop written job descriptions?

**A.** No. The ADA does not require employers to develop or maintain job descriptions. However, a written job description that is prepared before advertising or interviewing applicants for a job will be considered as evidence along with other relevant factors. If an employer uses job descriptions, they should be reviewed to make sure they accurately reflect the actual functions of a job. A job description will be most helpful if it focuses on the results or outcome of a job function, not solely on the way it customarily is performed. A reasonable accommodation may enable a person with a disability to accomplish a job function in a manner that is different from the way an employee who is not disabled may accomplish the same function.

**Q.** What is “reasonable accommodation?”

**A.** Reasonable accommodation is any modification or adjustment to a job or the work environment that will enable a qualified applicant or employee with a disability to participate in the application process or to perform essential job functions. Reasonable accommodation also includes adjustments to assure that a qualified individual with a disability has rights and privileges in employment equal to those of employees without disabilities.

**Q.** What are some of the accommodations applicants and employees may need?

**A.** Examples of reasonable accommodation include making existing facilities used by employees readily accessible to and usable by an individual with a disability; restructuring a job; modifying work schedules; acquiring or modifying equipment; providing qualified readers or interpreters; or appropriately modifying examinations, training, or other programs. Reasonable accommodation also may include reassigning a current employee to a vacant position for which the individual is qualified, if the person is unable to do the original job because of a disability even with an accommodation. However, there is no obligation to find a position for an applicant who is not qualified for the position sought. Employers are not required to lower quality or quantity standards as an accommodation; nor are they obligated to provide personal use items such as glasses or hearing aids.

The decision as to the appropriate accommodation must be based on the particular facts of each case. In selecting the particular type of reasonable accommodation to provide, the principal test is that of effectiveness, i.e., whether the accommodation will provide an opportunity for a person with a disability to achieve the same level of performance and to enjoy benefits equal to those of an average, similarly situated person without a disability. However, the accommodation does not have to ensure equal results or provide exactly the same benefits.

**Q.** When is an employer required to make a reasonable accommodation?

**A.** An employer is only required to accommodate a “known” disability of a qualified applicant or employee. The requirement generally will be triggered by a request from an individual with a disability, who frequently will be able to suggest an appropriate accommodation. Accommodations must be made on an individual basis, because the nature and extent of a disabling condition and the requirements of a job will vary in each case. If the individual does not request an accommodation, the employer is not obligated to provide one except where an individual’s known disability impairs his/her ability to know of, or effectively communicate a need for, an accommodation that is obvious to the employer. If a person with a disability requests, but cannot suggest, an appropriate accommodation, the employer and the individual should work together to identify one. There are also many public and private resources that can provide assistance without cost.

**Q.** What are the limitations on the obligation to make a reasonable accommodation?

**A.** The individual with a disability requiring the accommodation must be otherwise qualified, and the disability must be known to the employer. In addition, an employer is not required to make an accommodation if it would impose an “undue hardship” on the operation of the employer’s business.



“Undue hardship” is defined as an “action requiring significant difficulty or expense” when considered in light of a number of factors. These factors include the nature and cost of the accommodation in relation to the size, resources, nature, and structure of the employer’s operation. Undue hardship is determined on a case-by-case basis. Where the facility making the accommodation is part of a larger entity, the structure and overall resources of the larger organization would be considered, as well as the financial and administrative relationship of the facility to the larger organization. In general, a larger employer with greater resources would be expected to make accommodations requiring greater effort or expense than would be required of a smaller employer with fewer resources.

If a particular accommodation would be an undue hardship, the employer must try to identify another accommodation that will not pose such a hardship. Also, if the cost of an accommodation would impose an undue hardship on the employer, the individual with a disability should be given the option of paying that portion of the cost which would constitute an undue hardship or providing the accommodation.

**Q.** Must an employer modify existing facilities to make them accessible?

**A.** The employer’s obligation under title I is to provide access for an individual applicant to participate in the job application process, and for an individual employee with a disability to perform the essential functions of his/her job, including access to a building, to the work site, to needed equipment, and to all facilities used by employees. For example, if an employee lounge is located in a place inaccessible to an employee using a wheelchair, the lounge might be modified or relocated, or comparable facilities might be provided in a location that would enable the individual to take a break with co-workers. The employer must provide such access unless it would cause an undue hardship.

Under title I, an employer is not required to make its existing facilities accessible until a particular applicant or employee with a particular disability needs an accommodation, and then the modifications should meet that individual’s work needs. However, employers should consider initiating changes that will provide general accessibility, particularly for job applicants, since it is likely that people with disabilities will be applying for jobs. The employer does not have to make changes to provide access in places or facilities that will not be used by that individual for employment-related activities or benefits.

**Q.** Can an employer be required to reallocate an essential function of a job to another employee as a reasonable accommodation?

**A.** No. An employer is not required to reallocate essential functions of a job as a reasonable accommodation.

**Q.** Can an employer be required to modify, adjust, or make other reasonable accommodations in the way a test is given to a qualified applicant or employee with a disability?

**A.** Yes. Accommodations may be needed to assure that tests or examinations measure the actual ability of an individual to perform job functions rather than reflect limitations caused by the disability. Tests should be given to people who have sensory, speaking, or manual impairments in a format that does not require the use of the impaired skill, unless it is a job-related skill that the test is designed to measure.

**Q.** Can an employer maintain existing production/performance standards for an employee with a disability?

**A.** An employer can hold employees with disabilities to the same standards of production/performance as other similarly situated employees without disabilities for performing essential job functions, with or without reasonable accommodation. An employer also can hold employees with disabilities to the same standards of production/performance as other employees regarding marginal functions unless the disability affects the person's ability to perform those marginal functions. If the ability to perform marginal functions is affected by the disability, the employer must provide some type of reasonable accommodation such as job restructuring but may not exclude an individual with a disability who is satisfactorily performing a job's essential functions.

**Q.** Can an employer establish specific attendance and leave policies?

**A.** An employer can establish attendance and leave policies that are uniformly applied to all employees, regardless of disability, but may not refuse leave needed by an employee with a disability if other employees get such leave. An employer also may be required to make adjustments in leave policy as a reasonable accommodation. The employer is not obligated to provide additional paid leave, but accommodations may include leave flexibility and unpaid leave.

A uniformly applied leave policy does not violate the ADA because it has a more severe effect on an individual because of his/her disability. However, if an individual with a disability requests a modification of such a policy as a reasonable accommodation, an employer may be required to provide it, unless it would impose an undue hardship.

**Q.** Can an employer consider health and safety when deciding whether to hire an applicant or retain an employee with a disability?

**A.** Yes. The ADA permits employers to establish qualification standards that will exclude individuals who pose a direct threat—i.e., a significant risk of substantial harm—to the health or safety of the individual or of others, if that risk cannot be eliminated or reduced below the level of a “direct threat” by

reasonable accommodation. However, an employer may not simply assume that a threat exists; the employer must establish through objective, medically supportable methods that there is significant risk that substantial harm could occur in the workplace. By requiring employers to make individualized judgments based on reliable medical or other objective evidence rather than on generalizations, ignorance, fear, patronizing attitudes, or stereotypes, the ADA recognizes the need to balance the interests of people with disabilities against the legitimate interests of employers in maintaining a safe workplace.

**Q.** Are applicants or employees who are currently illegally using drugs covered by the ADA?

**A.** No. Individuals who currently engage in the illegal use of drugs are specifically excluded from the definition of a “qualified individual with a disability” protected by the ADA when the employer takes action on the basis of their drug use.

**Q.** Is testing for the illegal use of drugs permissible under the ADA?

**A.** Yes. A test for the illegal use of drugs is not considered a medical examination under the ADA; therefore, employers may conduct such testing of applicants or employees and make employment decisions based on the results. The ADA does not encourage, prohibit, or authorize drug tests.

If the results of a drug test reveal the presence of a lawfully prescribed drug or other medical information, such information must be treated as a confidential medical record.

**Q.** Are alcoholics covered by the ADA?

**A.** Yes. While a current illegal user of drugs is not protected by the ADA if an employer acts on the basis of such use, a person who currently uses alcohol is not automatically denied protection. An alcoholic is a person with a disability and is protected by the ADA if s/he is qualified to perform the essential functions of the job. An employer may be required to provide an accommodation to an alcoholic. However, an employer can discipline, discharge or deny employment to an alcoholic whose use of alcohol adversely affects job performance or conduct. An employer also may prohibit the use of alcohol in the workplace and can require that employees not be under the influence of alcohol.

**Q.** Does the ADA override Federal and State health and safety laws?

**A.** The ADA does not override health and safety requirements established under other Federal laws even if a standard adversely affects the employment of an individual with a disability. If a standard is required by another Federal law, an employer must comply with it and does not have to show that the standard is job related and consistent with business necessity.

For example, employers must conform to health and safety requirements of the U.S. Occupational Safety and Health Administration. However, an employer still has the obligation under the ADA to consider whether there is a reasonable accommodation, consistent with the standards of other Federal laws, that will prevent exclusion of qualified individuals with disabilities who can perform jobs without violating the standards of those laws. If an employer can comply with both the ADA and another Federal law, then the employer must do so.

The ADA does not override State or local laws designed to protect public health and safety, except where such laws conflict with the ADA requirements. If there is a State or local law that would exclude an individual with a disability from a particular job or profession because of a health or safety risk, the employer still must assess whether a particular individual would pose a “direct threat” to health or safety under the ADA standard. If such a “direct threat” exists, the employer must consider whether it could be eliminated or reduced below the level of a “direct threat” by reasonable accommodation. An employer cannot rely on a State or local law that conflicts with ADA requirements as a defense to a charge of discrimination.

**Q.** How does the ADA affect workers’ compensation programs?

**A.** Only injured workers who meet the ADA’s definition of an “individual with a disability” will be considered disabled under the ADA, regardless of whether they satisfy criteria for receiving benefits under workers’ compensation or other disability laws. A worker also must be “qualified” (with or without reasonable accommodation) to be protected by the ADA. Work-related injuries do not always cause physical or mental impairments severe enough to “substantially limit” a major life activity. Also, many on-the-job injuries cause temporary impairments which heal within a short period of time with little or no long-term or permanent impact. Therefore, many injured workers who qualify for benefits under workers’ compensation or other disability benefits laws may not be protected by the ADA. An employer must consider work-related injuries on a case-by-case basis to know if a worker is protected by the ADA.

An employer may not inquire into an applicant’s workers’ compensation history before making a conditional offer of employment. After making a conditional job offer, an employer may inquire about a person’s workers compensation history in a medical inquiry or examination that is required of all applicants in the same job category. However, even after a conditional offer has been made, an employer cannot require a potential employee to have a medical examination because a response to a medical inquiry (as opposed to results from a medical examination) shows a previous on-the-job injury unless all applicants in the same job category are required to have an

examination. Also, an employer may not base an employment decision on the speculation that an applicant may cause increased workers' compensation costs in the future. However, an employer may refuse to hire, or may discharge an individual who is not currently able to perform a job without posing a significant risk of substantial harm to the health or safety of the individual or others, if the risk cannot be eliminated or reduced by reasonable accommodation.

An employer may refuse to hire or may fire a person who knowingly provides a false answer to a lawful post-offer inquiry about his/her condition or worker's compensation history.

An employer also may submit medical information and records concerning employees and applicants (obtained after a conditional job offer) to state workers' compensation offices and "second injury" funds without violating ADA confidentiality requirements.

**Q.** What is discrimination based on "relationship or association" under the ADA?

**A.** The ADA prohibits discrimination based on relationship or association in order to protect individuals from actions based on unfounded assumptions that their relationship to a person with a disability would affect their job performance, and from actions caused by bias or misinformation concerning certain disabilities. For example, this provision would protect a person whose spouse has a disability from being denied employment because of an employer's unfounded assumption that the applicant would use excessive leave to care for the spouse. It also would protect an individual who does volunteer work for people with AIDS from a discriminatory employment action motivated by that relationship or association.

**Q.** How are the employment provisions enforced?

**A.** The employment provisions of the ADA are enforced under the same procedures now applicable to race, color, sex, national origin, and religious discrimination under title VII of the Civil Rights Act of 1964, as amended, and the Civil Rights Act of 1991. Complaints regarding actions that occurred on or after July 26, 1992, may be filed with the Equal Employment Opportunity Commission or designated State human rights agencies. Available remedies will include hiring, reinstatement, promotion, back pay, front pay, restored benefits, reasonable accommodation, attorneys' fees, expert witness fees, and court costs. Compensatory and punitive damages also may be available in cases of intentional discrimination or where an employer fails to make a good faith effort to provide a reasonable accommodation.

**Q.** What financial assistance is available to employers to help them make reasonable accommodations and comply with the ADA?

**A.** A special tax credit is available to help smaller employers make accommodations required by the ADA. An eligible small business may take a tax credit of up to \$5,000 per year for accommodations made to comply with the ADA. The credit is available for one-half the cost of “eligible access expenditures” that are more than \$250 but less than \$10,250.

A full tax deduction, up to \$15,000 per year, also is available to any business for expenses of removing qualified architectural or transportation barriers. Expenses covered include costs of removing barriers created by steps, narrow doors, inaccessible parking spaces, restroom facilities, and transportation vehicles. Additional information discussing the tax credits and deductions is contained in the Department of Justice’s ADA Tax Incentive Packet for Businesses available from the ADA Information Line. Information about the tax credit and tax deduction can also be obtained from a local IRS office, or by contacting the Office of Chief Counsel, Internal Revenue Service.

**Q.** What are an employer’s record keeping requirements under the employment provisions of the ADA?

**A.** An employer must maintain records such as application forms submitted by applicants and other records related to hiring, requests for reasonable accommodation, promotion, demotion, transfer, lay-off or termination, rates of pay or other terms of compensation, and selection for training or apprenticeship for one year after making the record or taking the action described (whichever occurs later). If a charge of discrimination is filed or an action is brought by EEOC, an employer must save all personnel records related to the charge until final disposition of the charge.

**Q.** Does the ADA require that an employer post a notice explaining its requirements?

**A.** The ADA requires that employers post a notice describing the provisions of the ADA. It must be made accessible, as needed, to individuals with disabilities. A poster is available from EEOC summarizing the requirements of the ADA and other Federal legal requirements for nondiscrimination for which EEOC has enforcement responsibility. EEOC also provides guidance on making this information available in accessible formats for people with disabilities.

**Q.** What resources does the Equal Employment Opportunity Commission have available to help employers and people with disabilities understand and comply with the employment requirements of the ADA?

**A.** The Equal Employment Opportunity Commission has developed several resources to help employers and people with disabilities understand and comply with the employment provisions of the ADA. Resources include: a technical assistance manual that provides “how-to” guidance on the employment provisions of the ADA as well as a resource directory to help individuals find specific information, and a variety of brochures, booklets, and fact sheets.

## **State and Local Governments**

**Q.** Does the ADA apply to State and local governments?

**A.** Title II of the ADA prohibits discrimination against qualified individuals with disabilities in all programs, activities, and services of public entities. It applies to all State and local governments, their departments and agencies, and any other instrumentalities or special purpose districts of State or local governments. It clarifies the requirements of section 504 of the Rehabilitation Act of 1973 for public transportation systems that receive Federal financial assistance, and extends coverage to all public entities that provide public transportation, whether or not they receive Federal financial assistance. It establishes detailed standards for the operation of public transit systems, including commuter and intercity rail (AMTRAK).

**Q.** When do the requirements for State and local governments become effective?

**A.** In general, they became effective on January 26, 1992.

**Q.** How does title II affect participation in a State or local government’s programs, activities, and services?

**A.** A state or local government must eliminate any eligibility criteria for participation in programs, activities, and services that screen out or tend to screen out persons with disabilities, unless it can establish that the requirements are necessary for the provision of the service, program, or activity. The State or local government may, however, adopt legitimate safety requirements necessary for safe operation if they are based on real risks, not on stereotypes or generalizations about individuals with disabilities. Finally, a public entity must reasonably modify its policies, practices, or procedures to avoid discrimination. If the public entity can demonstrate that a particular modification would fundamentally alter the nature of its service, program, or activity, it is not required to make that modification.

**Q.** Does title II cover a public entity's employment policies and practices?

**A.** Yes. Title II prohibits all public entities, regardless of the size of their work force, from discriminating in employment against qualified individuals with disabilities. In addition to title II's employment coverage, title I of the ADA and section 504 of the Rehabilitation Act of 1973 prohibit employment discrimination against qualified individuals with disabilities by certain public entities.

**Q.** What changes must a public entity make to its existing facilities to make them accessible?

**A.** A public entity must ensure that individuals with disabilities are not excluded from services, programs, and activities because existing buildings are inaccessible. A State or local government's programs, when viewed in their entirety, must be readily accessible to and usable by individuals with disabilities. This standard, known as "program accessibility," applies to facilities of a public entity that existed on January 26, 1992. Public entities do not necessarily have to make each of their existing facilities accessible. They may provide program accessibility by a number of methods including alteration of existing facilities, acquisition or construction of additional facilities, relocation of a service or program to an accessible facility, or provision of services at alternate accessible sites.

**Q.** When must structural changes be made to attain program accessibility?

**A.** Structural changes needed for program accessibility must be made as expeditiously as possible, and should have been made by January 26, 1995. This three-year time period is not a grace period; all alterations must be accomplished as expeditiously as possible. A public entity that employs 50 or more persons must have developed a transition plan by July 26, 1992, setting forth the steps necessary to complete such changes.

**Q.** What is a self-evaluation?

**A.** A self-evaluation is a public entity's assessment of its current policies and practices. The self-evaluation identifies and corrects those policies and practices that are inconsistent with title II's requirements. All public entities should have completed a self-evaluation by January 26, 1993. A public entity that employs 50 or more employees must retain its self-evaluation for three years. Other public entities are not required to retain their self-evaluations, but are encouraged to do so because these documents evidence a public entity's good faith efforts to comply with title II's requirements.

**Q.** What does title II require for new construction and alterations?

**A.** The ADA requires that all new buildings constructed by a State or local government be accessible. In addition, when a State or local government undertakes alterations to a building, it must make the altered portions accessible.



**Q.** How will a State or local government know that a new building is accessible?

**A.** A State or local government will be in compliance with the ADA for new construction and alterations if it follows either of two accessibility standards. It can choose either the Uniform Federal Accessibility Standards or the Americans with Disabilities Act Accessibility Guidelines for Buildings and Facilities, which is the standard that must be used for public accommodations and commercial facilities under title III of the ADA. If the State or local government chooses the ADA Accessibility Guidelines, it is not entitled to the elevator exemption (which permits certain private buildings under three stories or under 3,000 square feet per floor to be constructed without an elevator).

**Q.** What requirements apply to a public entity's emergency telephone services, such as 911?

**A.** State and local agencies that provide emergency telephone services must provide "direct access" to individuals who rely on a TDD or computer modem for telephone communication. Telephone access through a third party or through a relay service does not satisfy the requirement for direct access. Where a public entity provides 911 telephone service, it may not substitute a separate seven-digit telephone line as the sole means for access to 911 services by nonvoice users. A public entity may, however, provide a separate seven-digit line for the exclusive use of nonvoice callers in addition to providing direct access for such calls to its 911 line.

**Q.** Does title II require that telephone emergency service systems be compatible with all formats used for nonvoice communications?

**A.** No. At present, telephone emergency services must only be compatible with the Baudot format. Until it can be technically proven that communications in another format can operate in a reliable and compatible manner in a given telephone emergency environment, a public entity would not be required to provide direct access to computer modems using formats other than Baudot.

**Q.** How will the ADA's requirements for State and local governments be enforced?

**A.** Private individuals may bring lawsuits to enforce their rights under title II and may receive the same remedies as those provided under section 504 of the Rehabilitation Act of 1973, including reasonable attorney's fees. Individuals may also file complaints with eight designated Federal agencies, including the Department of Justice and the Department of Transportation.

## Public Accommodations

**Q.** What are public accommodations?

**A.** A public accommodation is a private entity that owns, operates, leases, or leases to, a place of public accommodation. Places of public accommodation include a wide range of entities, such as restaurants, hotels, theaters, doctors' offices, pharmacies, retail stores, museums, libraries, parks, private schools, and day care centers. Private clubs and religious organizations are exempt from the ADA's title III requirements for public accommodations.

**Q.** Will the ADA have any effect on the eligibility criteria used by public accommodations to determine who may receive services?

**A.** Yes. If a criterion screens out or tends to screen out individuals with disabilities, it may only be used if necessary for the provision of the services. For instance, it would be a violation for a retail store to have a rule excluding all deaf persons from entering the premises, or for a movie theater to exclude all individuals with cerebral palsy. More subtle forms of discrimination are also prohibited. For example, requiring presentation of a driver's license as the sole acceptable means of identification for purposes of paying by check could constitute discrimination against individuals with vision impairments. This would be true if such individuals are ineligible to receive licenses and the use of an alternative means of identification is feasible.

**Q.** Does the ADA allow public accommodations to take safety factors into consideration in providing services to individuals with disabilities?

**A.** The ADA expressly provides that a public accommodation may exclude an individual, if that individual poses a direct threat to the health or safety of others that cannot be mitigated by appropriate modifications in the public accommodation's policies or procedures, or by the provision of auxiliary aids. A public accommodation will be permitted to establish objective safety criteria for the operation of its business; however, any safety standard must be based on objective requirements rather than stereotypes or generalizations about the ability of persons with disabilities to participate in an activity.

**Q.** Are there any limits on the kinds of modifications in policies, practices, and procedures required by the ADA?

**A.** Yes. The ADA does not require modifications that would fundamentally alter the nature of the services provided by the public accommodation. For example, it would not be discriminatory for a physician specialist who treats only burn patients to refer a deaf individual to another physician for treatment of a broken limb or respiratory ailment. To require a physician to accept patients outside of his or her specialty would fundamentally alter the nature of the medical practice.

**Q.** What kinds of auxiliary aids and services are required by the ADA to ensure effective communication with individuals with hearing or vision impairments?

**A.** Appropriate auxiliary aids and services may include services and devices such as qualified interpreters, assistive listening devices, notetakers, and written materials for individuals with hearing impairments; and qualified readers, taped texts, and Brailled or large print materials for individuals with vision impairments.

**Q.** Are there any limitations on the ADA's auxiliary aids requirements?

**A.** Yes. The ADA does not require the provision of any auxiliary aid that would result in an undue burden or in a fundamental alteration in the nature of the goods or services provided by a public accommodation. However, the public accommodation is not relieved from the duty to furnish an alternative auxiliary aid, if available, that would not result in a fundamental alteration or undue burden. Both of these limitations are derived from existing regulations and case law under section 504 of the Rehabilitation Act and are to be determined on a case-by-case basis.

**Q.** Will restaurants be required to have brailled menus?

**A.** No, not if waiters or other employees are made available to read the menu to a blind customer.

**Q.** Will a clothing store be required to have brailled price tags?

**A.** No, not if sales personnel could provide price information orally upon request.

**Q.** Will a bookstore be required to maintain a sign language interpreter on its staff in order to communicate with deaf customers?

**A.** No, not if employees communicate by pen and notepad when necessary.

**Q.** Are there any limitations on the ADA's barrier removal requirements for existing facilities?

**A.** Yes. Barrier removal need be accomplished only when it is "readily achievable" to do so.

**Q.** What does the term "readily achievable" mean?

**A.** It means "easily accomplishable and able to be carried out without much difficulty or expense."

**Q.** What are examples of the types of modifications that would be readily achievable in most cases?

**A.** Examples include the simple ramping of a few steps, the installation of grab bars where only routine reinforcement of the wall is required, the lowering of telephones, and similar modest adjustments.

**Q.** Will businesses need to rearrange furniture and display racks?

**A.** Possibly. For example, restaurants may need to rearrange tables and department stores may need to adjust their layout of racks and shelves in order to permit access to wheelchair users.

**Q.** Will businesses need to install elevators?

**A.** Businesses are not required to retrofit their facilities to install elevators unless such installation is readily achievable, which is unlikely in most cases.

**Q.** When barrier removal is not readily achievable, what kinds of alternative steps are required by the ADA?

**A.** Alternatives may include such measures as in-store assistance for removing articles from inaccessible shelves, home delivery of groceries, or coming to the door to receive or return dry cleaning.

**Q.** Must alternative steps be taken without regard to cost?

**A.** No, only readily achievable alternative steps must be undertaken.

**Q.** How is “readily achievable” determined in a multisite business?

**A.** In determining whether an action to make a public accommodation accessible would be “readily achievable,” the overall size of the parent corporation or entity is only one factor to be considered. The ADA also permits consideration of the financial resources of the particular facility or facilities involved and the administrative or fiscal relationship of the facility or facilities to the parent entity.

**Q.** Who has responsibility for ADA compliance in leased places of public accommodation, the landlord or the tenant?

**A.** The ADA places the legal obligation to remove barriers or provide auxiliary aids and services on both the landlord and the tenant. The landlord and the tenant may decide by lease who will actually make the changes and provide the aids and services, but both remain legally responsible.

**Q.** What does the ADA require in new construction?

**A.** The ADA requires that all new construction of places of public accommodation, as well as of “commercial facilities” such as office buildings, be accessible. Elevators are generally not required in facilities under three stories or with fewer than 3,000 square feet per floor, unless the building is a shopping center or mall; the professional office of a health care provider; a terminal, depot, or other public transit station; or an airport passenger terminal.

**Q.** Is it expensive to make all newly constructed places of public accommodation and commercial facilities accessible?

**A.** The cost of incorporating accessibility features in new construction is less than one percent of construction costs. This is a small price in relation to the economic benefits to be derived from full accessibility in the future, such as increased employment and consumer spending and decreased welfare dependency.

**Q.** Must every feature of a new facility be accessible?

**A.** No, only a specified number of elements such as parking spaces and drinking fountains must be made accessible in order for a facility to be “readily accessible.” Certain nonoccupiable spaces such as elevator pits, elevator penthouses, and piping or equipment catwalks need not be accessible.

**Q.** What are the ADA requirements for altering facilities?

**A.** All alterations that could affect the usability of a facility must be made in an accessible manner to the maximum extent feasible. For example, if during renovations a doorway is being relocated, the new doorway must be wide enough to meet the new construction standard for accessibility. When alterations are made to a primary function area, such as the lobby of a bank or the dining area of a cafeteria, an accessible path of travel to the altered area must also be provided. The bathrooms, telephones, and drinking fountains serving that area must also be made accessible. These additional accessibility alterations are only required to the extent that the added accessibility costs do not exceed 20% of the cost of the original alteration. Elevators are generally not required in facilities under three stories or with fewer than 3,000 square feet per floor, unless the building is a shopping center or mall; the professional office of a health care provider; a terminal, depot, or other public transit station; or an airport passenger terminal.

**Q.** Does the ADA permit an individual with a disability to sue a business when that individual believes that discrimination is about to occur, or must the individual wait for the discrimination to occur?

**A.** The ADA public accommodations provisions permit an individual to allege discrimination based on a reasonable belief that discrimination is about to occur. This provision, for example, allows a person who uses a wheelchair to challenge the planned construction of a new place of public accommodation, such as a shopping mall, that would not be accessible to individuals who use wheelchairs. The resolution of such challenges prior to the construction of an inaccessible facility would enable any necessary remedial measures to be incorporated in the building at the planning stage, when such changes would be relatively inexpensive.

**Q.** How does the ADA affect existing State and local building codes?

**A.** Existing codes remain in effect. The ADA allows the Attorney General to certify that a State law, local building code, or similar ordinance that establishes accessibility requirements meets or exceeds the minimum accessibility requirements for public accommodations and commercial facilities. Any State or local government may apply for certification of its code or ordinance. The Attorney General can certify a code or ordinance only after prior notice and a public hearing at which interested people, including individuals with disabilities, are provided an opportunity to testify against the certification.

**Q.** What is the effect of certification of a State or local code or ordinance?

**A.** Certification can be advantageous if an entity has constructed or altered a facility according to a certified code or ordinance. If someone later brings an enforcement proceeding against the entity, the certification is considered “rebuttable evidence” that the State law or local ordinance meets or exceeds the minimum requirements of the ADA. In other words, the entity can argue that the construction or alteration met the requirements of the ADA because it was done in compliance with the State or local code that had been certified.

**Q.** When are the public accommodations provisions effective?

**A.** In general, they became effective on January 26, 1992.

**Q.** How will the public accommodations provisions be enforced?

**A.** Private individuals may bring lawsuits in which they can obtain court orders to stop discrimination. Individuals may also file complaints with the Attorney General, who is authorized to bring lawsuits in cases of general public importance or where a “pattern of practice” of discrimination is alleged. In these cases, the Attorney General may seek monetary damages and civil penalties. Civil penalties may not exceed \$55,000 for a first violation or \$110,000 for any subsequent violation.

### **Miscellaneous**

**Q.** Is the Federal government covered by the ADA?

**A.** The ADA does not cover the executive branch of the Federal government. The executive branch continues to be covered by title V of the Rehabilitation Act of 1973, which prohibits discrimination in services and employment on the basis of handicap and which is a model for the requirements of the ADA. The ADA, however, does cover Congress and other entities in the legislative branch of the Federal government.

**Q.** Does the ADA cover private apartments and private homes?

**A.** The ADA does not cover strictly residential private apartments and homes. If, however, a place of public accommodation, such as a doctor's office or day care center, is located in a private residence, those portions of the residence used for that purpose are subject to the ADA's requirements.

**Q.** Does the ADA cover air transportation?

**A.** Discrimination by air carriers in areas other than employment is not covered by the ADA but rather by the Air Carrier Access Act (49 U.S.C. 1374 (c)).

**Q.** What are the ADA's requirements for public transit buses?

**A.** The Department of Transportation has issued regulations mandating accessible public transit vehicles and facilities. The regulations include requirements that all new fixed-route, public transit buses be accessible and that supplementary paratransit services be provided for those individuals with disabilities who cannot use fixed-route bus service.

**Q.** How will the ADA make telecommunications accessible?

**A.** The ADA requires the establishment of telephone relay services for individuals who use telecommunications devices for deaf persons (TDD's) or similar devices. The Federal Communications Commission has issued regulations specifying standards for the operation of these services.

**Q.** Are businesses entitled to any tax benefit to help pay for the cost of compliance?

**A.** As amended in 1990, the Internal Revenue Code allows a deduction of up to \$15,000 per year for expenses associated with the removal of qualified architectural and transportation barriers. The 1990 amendment also permits eligible small businesses to receive a tax credit for certain costs of compliance with the ADA. An eligible small business is one whose gross receipts do not exceed \$1,000,000 or whose workforce does not consist of more than 30 full-time workers. Qualifying businesses may claim a credit of up to 50 percent of eligible access expenditures that exceed \$250 but do not exceed \$10,250. Examples of eligible access expenditures include the necessary and reasonable costs of removing architectural, physical, communications, and transportation barriers; providing readers, interpreters, and other auxiliary aids; and acquiring or modifying equipment or devices.

## RESOURCES

### ACCESS AS A CIVIL RIGHT

#### **“A Chronology of the Disability Rights Movement”**

Office of Human Relations' Disability Programs Unit, San Francisco State University  
[www.sfsu.edu/~dprc/chronology/chron50s.html](http://www.sfsu.edu/~dprc/chronology/chron50s.html)

#### **“The Disability Rights Movement: A Brief History”**

Access and Opportunities: A Guide to Disability Awareness, U.S. Society & Values-USIA Electronic Journal, Vol. 4, No. 1, January 1999  
<http://202.41.85.234:8000/InfoUSA/society/ijse0199/history.htm>

#### **Disability Social History Project**

This website has history, timelines, and more.  
[www.disabilityhistory.org](http://www.disabilityhistory.org)

### ADA REGULATIONS, ACCESSIBILITY STANDARDS, REQUIREMENTS AND TECHNICAL ASSISTANCE PUBLICATIONS

#### **Disability Rights Section**

Civil Rights Division  
U.S. Department of Justice  
950 Pennsylvania Avenue, NW  
Washington, D.C. 20530  
(800) 514-0301 voice  
(800) 514-0383 TTY  
[www.ada.gov](http://www.ada.gov)

#### **United States Access Board**

1331 F Street NW, Suite 1000  
Washington, D.C. 20004-1111  
(800) 872-2253 voice  
(800) 993-2822 TTY  
(202) 272-0081 fax  
[info@access-board.gov](mailto:info@access-board.gov)  
[www.access-board.gov](http://www.access-board.gov)



## **EMPLOYMENT AND ACCESSIBILITY FOR EMPLOYEES WITH DISABILITIES**

### **U.S. Equal Employment Opportunity Commission (EEOC)**

131 M Street NE  
Washington, D.C. 20507  
(800) 669-4000 voice  
(800) 669-6820 TTY  
[www.eeoc.gov](http://www.eeoc.gov)

### **The Job Accommodation Network (JAN)**

JAN provides information about job accommodations for people with disabilities.

Job Accommodation Network (JAN)  
West Virginia University  
P.O. Box 6080  
Morgantown, WV 26506-6080  
(800) 526-7234 voice  
(877) 781-9403 TTY  
<http://askjan.org>

### **ADA Centers: Disability and Business Technical Assistance Centers (DBTACs)**

Ten regional centers providing technical assistance and comprehensive resource on ADA issues in employment, public services, public accommodations and communications.

ADA Centers: DBTAC  
(800) 949-4232 voice/TTY  
[www.adata.org](http://www.adata.org)



photo by Marissa Roth

Mark Taper Forum, Los Angeles, CA: Backstage dressing room with actress Lisa Mann

# Architectural Access

## Universal Design

Universal design goes beyond minimum access standards to the design of products and environments usable by the broadest public to the greatest extent possible. The intent of universal design is to simplify life for everyone by making products, communications and the built environment usable by as many people as possible. In the best of all possible worlds, the concept of universal design would guide the creation of all facilities and programs.

Universal design benefits people of all ages and abilities because what is an accommodation for one person may be a convenience for many. The seven principles of universal design can be applied in many ways, not just to architecture and buildings, but also to programs and policies. For example: Does an organization's ticket sales system allow for flexibility in use? Can everyone purchase tickets on the phone, via the Internet or at the door? Is the system simple and intuitive? Are the purchasing policies simple and straightforward?

The following seven principles inform the creation of more inclusive and universally accessible environments.

These principles were compiled by advocates of universal design, listed in alphabetical order: Bettye Rose Connell, Mike Jones, Ron Mace, Jim Mueller, Abir Mullick, Elaine Ostroff, Jon Sanford, Ed Steinfeld, Molly Story and Gregg Vanderheiden, with major funding provided by the National Institute on Disability and Rehabilitation Research and the U.S. Department of Education, Copyright 1997, NC State University, The Center for Universal Design.

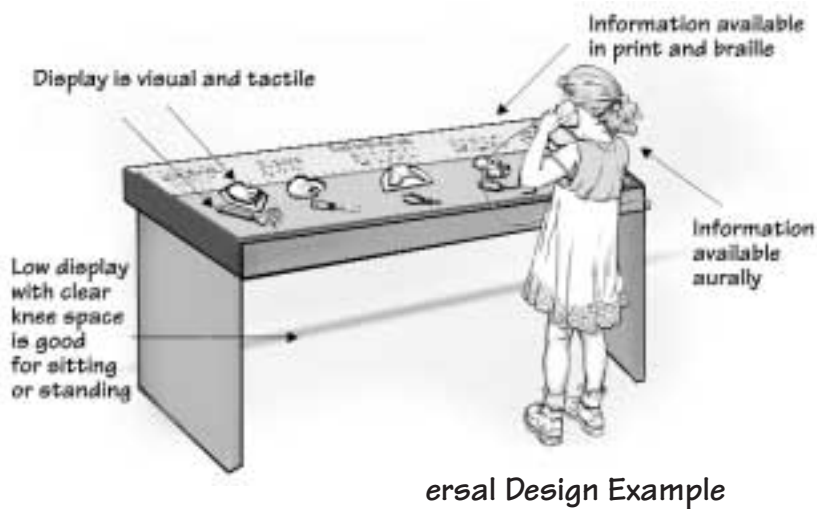

## Principle One: Equitable Use

The designs are useful and marketable to people with diverse abilities.

- Provide the same means of use for all users, identical whenever possible, equivalent when not.
- Avoid segregating or stigmatizing any users.
- Make provisions for privacy, security and safety equally available to all users.
- Make the design appealing to all users.

- Examples
  - Power doors with sensors at entrances that are convenient for all users.
  - Integrated, dispersed and adaptable seating in assembly areas such as theaters.

## Principle Two: Flexibility in Use

Designs accommodate a wide range of individual preferences and abilities.

- Provide choice in methods of use.
- Accommodate right- or left-handed access and use.
- Facilitate the user's accuracy and precision.
- Provide adaptability to the user's pace.
- Examples
  - Scissors designed for right- or left-handed users.
  - An automated teller machine (ATM) that has visual, tactile, and audio feedback, a tapered card opening and a palm rest.

## Principle Three: Simple and Intuitive Use

Uses of the designs are easy to understand, regardless of the user's experience, knowledge, language skills or current concentration level.

- Eliminate unnecessary complexity.
- Be consistent with user expectations and intuition.
- Accommodate a wide range of literacy and language skills.
- Arrange information consistent with its importance.
- Provide effective prompting and feedback during and after task completion.
- Examples
  - A moving sidewalk or escalator in a public space.
  - An instruction manual with drawings and no text.

## Principle Four: Perceptible Information

The designs communicate necessary information effectively to the user regardless of ambient conditions or the user's sensory abilities.

- Use different modes (pictorial, verbal, tactile) for redundant presentation of essential information.
- Provide adequate contrast between essential information and its surroundings.
- Maximize “legibility” of essential information.
- Differentiate elements in ways that can be described (make it easy to give instructions or directions).
- Provide compatibility with a variety of techniques or devices used by people with sensory limitations.
- Examples
  - Tactile, visual, and audible cues and instructions on a display with video or on a thermostat.
  - Redundant cueing (e.g. voice communications and signage) in airports, train stations and subway cars.

## Principle Five: Tolerance for Error

The designs minimize hazards and the adverse consequences of accidental or unintended actions.

- Arrange elements to minimize hazards and errors: most used elements, most accessible; hazardous elements eliminated, isolated or shielded.
- Provide warnings of hazards and errors.
- Provide fail-safe features.
- Discourage unconscious action in tasks that require vigilance.
- Examples
  - A double-cut key easily inserted into a recessed keyhole in either of two ways.
  - An “undo” feature in computer software that allows the user to correct mistakes without penalty.

**“You must understand that no matter what your occupation, we are all designers. Everything conceived or made by humans is designed. Universal design suggests that products, architecture, museum programs—all human-made things—must be functional and aesthetically enhancing, democratic, humane, adaptable, cost effective and inclusive. From huge systems such as urban planning, to a museum exhibition, down to a seemingly insignificant object like a can opener, designers must include the largest possible audience. I don’t think most people realize how design has an impact on every aspect of their daily lives.”**

Dianne H. Pilgrim, Director Emeritus and Senior Advisor for Special Projects, Cooper–Hewitt National Design Museum, Smithsonian Institution



### Principle Six: Low Physical Effort

The design can be used efficiently and comfortably and with a minimum of fatigue.

- Allow user to maintain a neutral body position.
- Use reasonable operating forces.
- Minimize repetitive actions.
- Minimize sustained physical effort.
- Examples
  - Lever or loop handles on doors and faucets.
  - Touch lamps operated without a switch.

### Principle Seven: Size and Space for Approach and Use

The design provides appropriate size and space for approaching, reaching, manipulating and using regardless of user's body size, posture or mobility.

- Provide a clear line of sight to important elements for any seated or standing user.
- Make reaching to all components comfortable for any seated or standing user.
- Accommodate variations in hand and grip size.
- Provide adequate space for using assistive devices or personal assistance.
- Examples
  - Controls on the front and clear floor space around an interactive exhibition, mailboxes and other elements.
  - Wide gates at subway station that accommodate all users.

**“Universal design is a new approach that assumes most places and programs can be designed to accommodate a much wider audience—if we plan from the beginning. It is becoming the approach used by cultural administrators who want their places, media and programs to reach the widest possible audience. Universal design helps develop audiences and careers and community.”**

Elaine Ostroff, Founding Director, Adaptive Environments

## **Surveying for Physical Accessibility**

Many arts and humanities programs are housed in facilities built before the Rehabilitation Act, the ADA, the conception of universal design, and before all of the architectural guidelines developed to increase accessibility. Nonetheless, cultural programs still require accessible buildings and spaces.

Whether the organization owns or leases a facility, whether the facility is old or new, there are five steps to ensuring physical accessibility.

### **1. Conduct a survey to identify accessibility barriers.**

A thorough survey should be conducted of every facility where cultural events occur. Use a reputable survey or checklist to identify barriers to accessibility. Involve knowledgeable individuals with disabilities in the process of evaluating what does and doesn't meet the Americans with Disabilities Act Accessibility Guidelines (ADAAG), Uniform Federal Accessibility Standards (UFAS), state or local accessibility standards and codes. Keep in mind that looking beyond the minimum level of accessibility laid out by codes and standards will broaden the potential for usability of facilities and programs.

### **2. Brainstorm ways in which barriers may be eliminated and ways in which environments may be made more universally accessible.**

Once the survey is completed, keep the principles of universal design in mind, examine the barriers identified and start creating solutions. For example, the front door leading into the organization's office has a round doorknob, which is difficult to turn. Solutions might include: removing the door knob, propping the door open, replacing the door knob with a levered handle or installing an electronic door opener.

### **3. Estimates of cost, time and resources involved in removing barriers and enhancing access.**

Take each proposed solution and cost it out. Figure out the time and resources necessary to accomplish each solution. Look at the practicality of each solution. For example, removing the doorknob or propping the door open isn't practical from a safety or security point of view. Installing an electronic door opener might be the optimal and most universal solution, but it may not be within the organization's financial reach. Replacing the round knob with a levered handle is the least expensive solution and will make the door more accessible.

#### **4. Prioritize projects and apply universal design principles to barrier removal efforts.**

After identifying solutions to barriers, determine in what order barrier removal will be accomplished. A good plan, both long-term and short-term, can maximize the effectiveness of barrier removal measures as well as the use of resources. Use the following priorities recommended by the U.S. Department of Justice while striving to create a universally accessible cultural environment.

First priority: Get people in the door.

Second priority: Provide access to goods and services.

Third priority: Provide access to restrooms.

Fourth priority: Remove any remaining barriers.

#### **5. Develop time frame, implement the plan and review it periodically.**

The final step is to develop the time frame and implement the plan. As in the examples above, fixing the barrier caused by the round doorknob would be a first priority because it involves getting people in the door. Initially, the plan would be to replace the round knob with a levered knob, but within two years identify or budget funds to install an electronic door opener. Reviewing and reassessing plans is very important. In two years, the organization may move to a different office space, the levered handle may provide suitable access or the electronic door may be a lot less expensive.

Even if an organization's permanent programs are in an accessible building, it may occasionally use other facilities temporarily or for a specific event. The organization should survey for accessibility. If the facilities are not accessible, the organization has two choices: either not use that facility or instigate barrier removal. For example, functions like festivals, circulating exhibitions or special performances may need temporary solutions to bypass a curb or a set of stairs, or to provide usable restrooms or improve signage. For conferences and meetings, the organization might negotiate with the site management to require accessibility improvements before signing an agreement to use the site.



Organizations that are building new or renovating old facilities should carefully select an architect and contractor who are willing to apply universal design concepts to their work and are committed to creating fully accessible environments. Architects and contractors should work with recognized specialists in the field of accessibility along with members of the local disability community who are fully aware of all applicable accessibility standards and sensitive to the environmental needs of people with disabilities.

---

The following is a preliminary guide to help identify areas that need particular attention, but it is not a comprehensive review of architectural accessibility standards. For a complete review of accessibility requirements, refer to either the Americans with Disabilities Act Accessibility Guidelines (ADAAG) or the Uniform Federal Accessibility Standards (UFAS), both of which can be obtained from:

The Access Board  
1331 F Street, NW, Suite 1000  
Washington, DC 20004-1111  
(800) 872-2253 voice  
(800) 993-2822 TTY  
info@access-board.gov  
www.access-board.gov

**“Every individual, no matter what age, needs accessible venues. We all benefit from a door that opens easily or a water fountain of an acceptable height. . . . In the new millennium our mandate is determined: accessibility for all. ”**

Denise Chavez, Artistic Director, The Border Book Festival



A Hazard at Small Changes in Level

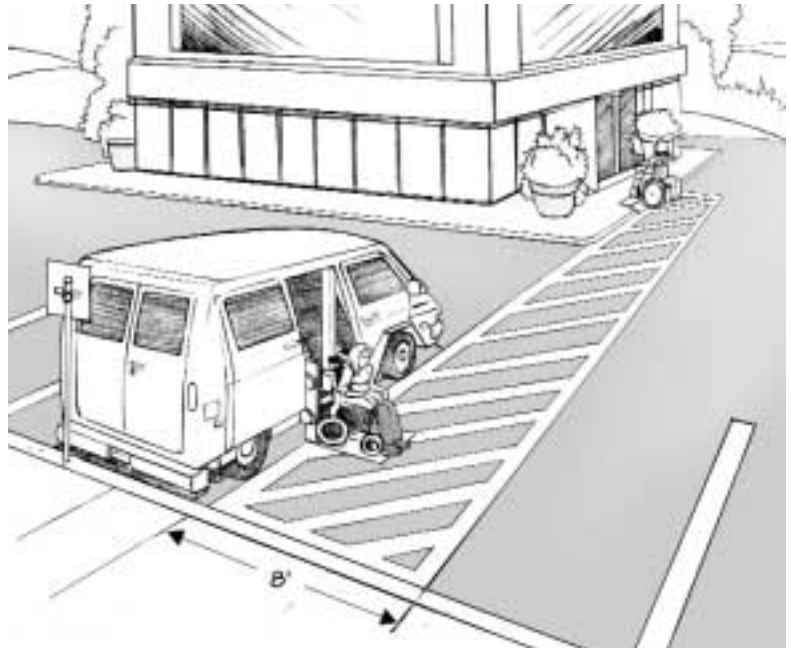

Exterior Accessible Route

## Preliminary Guide to Architectural Accessibility

### 1. Exterior Accessible Route

An accessible route is a continuous pathway with a stable, firm and slip-resistant surface at least 36 inches wide, which has no curbs, steps, stairs or abrupt changes in level greater than 1/4 inch. It should be free from sand, gravel, gratings, debris or anything that could trip people or result in an unstable or uneven surface.

An accessible route provides a safe and usable path for people who walk with difficulty, use wheelchairs, crutches, braces, canes or walkers, or who have respiratory or heart problems or other conditions that limit stamina or mobility. Accessible routes are also safer and easier for everyone to follow.

In surveying walks, paths, corridors and floor surfaces, look for small changes in level, steps and protruding objects (tree branches, shrubbery, signs, light fixtures). Holes and cracks should be filled in, bumps should be smoothed out, small changes in level should be ramped and thresholds should be level with the path or beveled. Curbs encountered on the accessible route must have curb ramps (commonly known as curb cuts). If a flight of stairs is the only available route, install a ramp or an elevator.

## 2. Parking

### Parking Spaces

Drivers who use wheelchairs need parking spaces on level surfaces that are 8 feet wide with a 5-foot access aisle next to them. The first accessible parking space and 1/8th of all parking spaces need to be able to accommodate vans with side lifts by having an 8-foot-wide access aisle. Each accessible space must be as close as possible to the accessible building entrance and adjoin an accessible route.

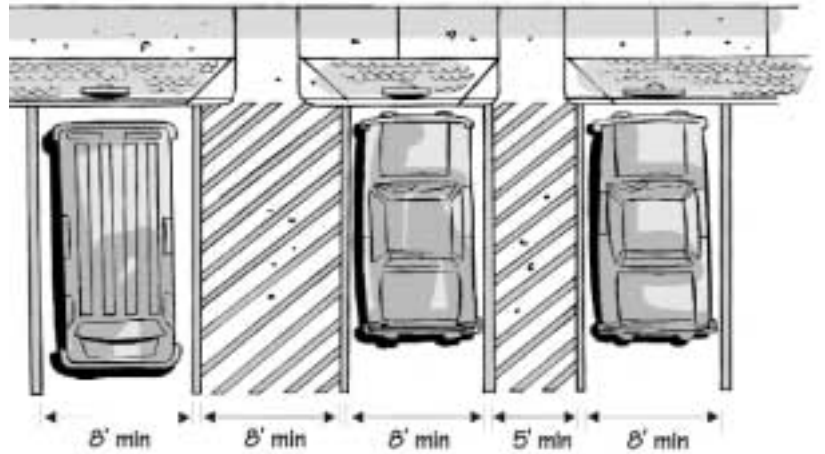

Accessible Parking Spaces with Accessible Aisles

The spaces must be marked by an above-ground sign that cannot be obscured by a vehicle parked in the space and that shows the international symbol of accessibility. The Americans with Disabilities Act Guidelines, Standard 4.30.7 (1) specify that facilities and elements, such as signs, required to be identified as accessible use the international symbol of accessibility. A sign painted on the pavement is required in some states but is not sufficient to satisfy federal requirements. Most large hardware stores carry ready-made signs. If the route is not apparent, provide signs directing people to an accessible entrance.



International Symbol of Accessibility

Both the UFAS and ADAAG (section 4.1.1) calculate the number of required accessible spaces as follows:

Total Parking Spaces	Minimum Number of Accessible Spaces Required
1 to 25	1
26 to 50	2
51 to 75	3
76 to 100	4
101 to 150	5
151 to 200	6
201 to 300	7
301 to 400	8
401 to 500	9
501 to 1000	2 percent of total
1001 and over	20 plus 1 for each 100 over 1000



Accessible Parking Signage

### Off-site Parking

If off-site parking is available, ensure that there is an accessible route of travel from the off-site parking to the facility's entrance. Mark the accessible route clearly with appropriate signage.

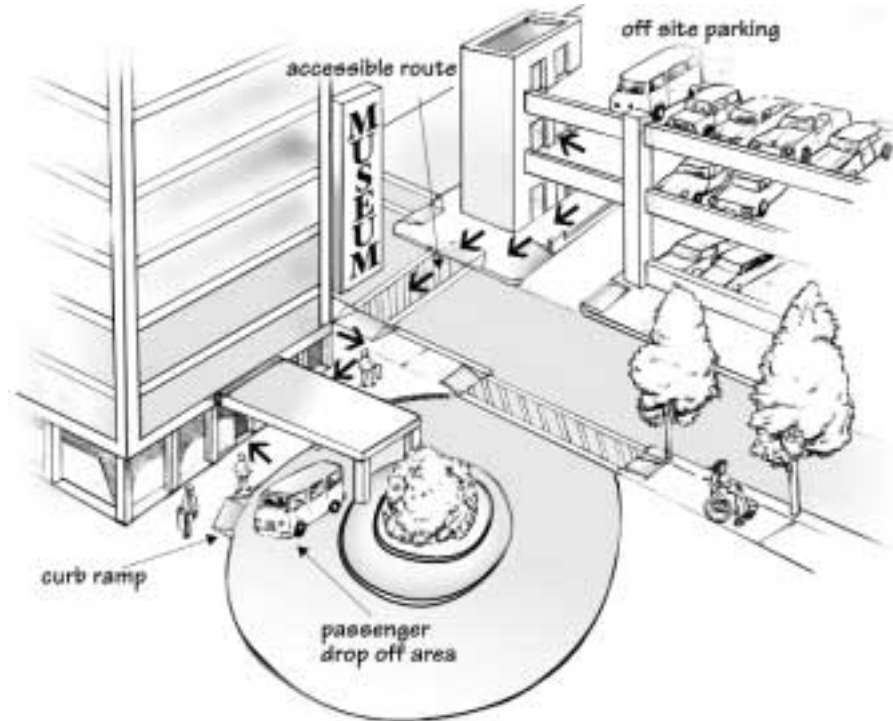

*Accessible Route from Off-Site Parking*

### Passenger-Loading Zone

A passenger-loading zone should have at least 5 feet of clear space beside the vehicle for passenger loading. The passenger-loading zone must connect to an accessible route to the building entry. Curbs at passenger drop-off zones must have curb cuts that are kept unobstructed.

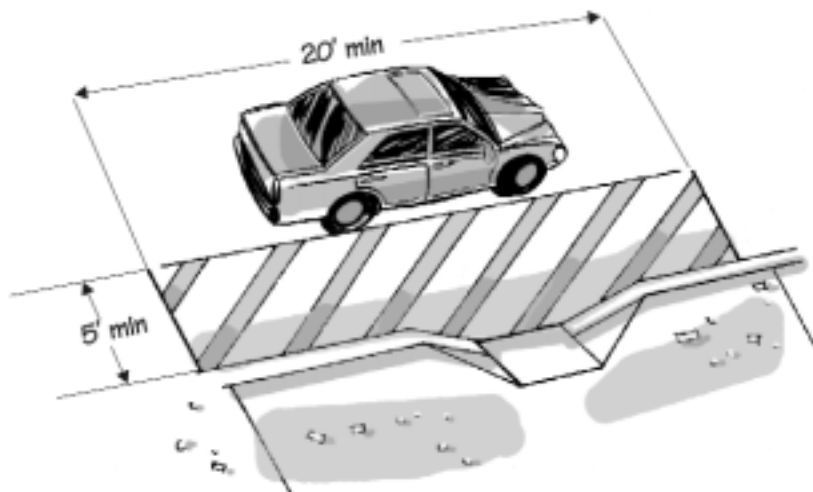

*Passenger Loading Zone*

### 3. Entrances and Doors

Entrances to buildings should be approached by a flat or gradually sloping and smooth surface. An accessible route must connect parking areas, drop-off zones, public transportation stops or other buildings with the building entrance.

#### Entrance Ramps

Most building standards specify ramps with a maximum slope of 8.3 percent, which is one foot of rise for every 12 feet of horizontal run. For every 30 feet of run an intermediate 5-foot long landing or rest platform is required. In addition, 5-foot level platforms must be at both the top and bottom of the ramp. Consequently, a ramp for a 4-foot rise must be at least 48 feet long plus have 5-foot long landings at the top and bottom and at least one level intermediate 5-foot long landing. Ramps are usually required to have hand railings on both sides.

Long ramps can be handled in a variety of ways: straight run, switch back or L-shape. Level approaches however, are always preferable to ramps. In some instances, particularly in historic buildings, re-landscaping the approach to change the entrance level may be the best solution. Also, interior ramps are always preferable to exterior ramps so that no one is required to roll or walk on an inclined surface during inclement weather.

#### Doorways and Thresholds

Doorways must provide a minimum of 32 inches of clearance when the door is standing open at 90 degrees. Most exterior doorways are 36 inches wide, but interior doors are often narrower. All doorways need a 5-foot by 5-foot level and clear area on the pull side. The door should have a kickplate and lever-type or push-pull or U-shaped hardware.

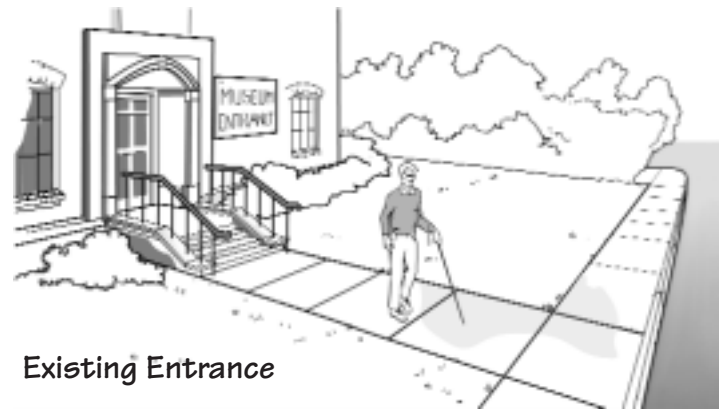

Existing Entrance

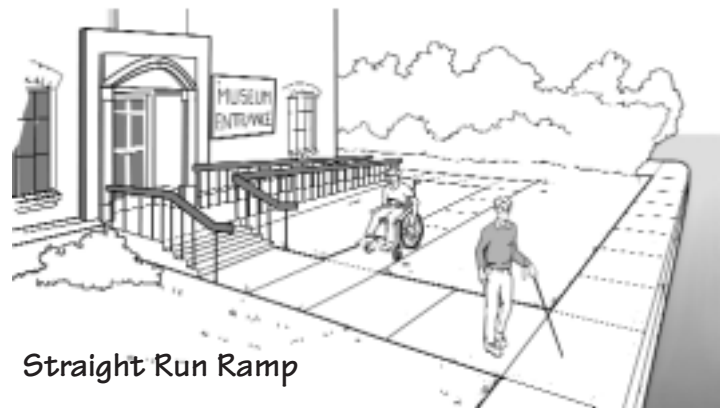

Straight Run Ramp

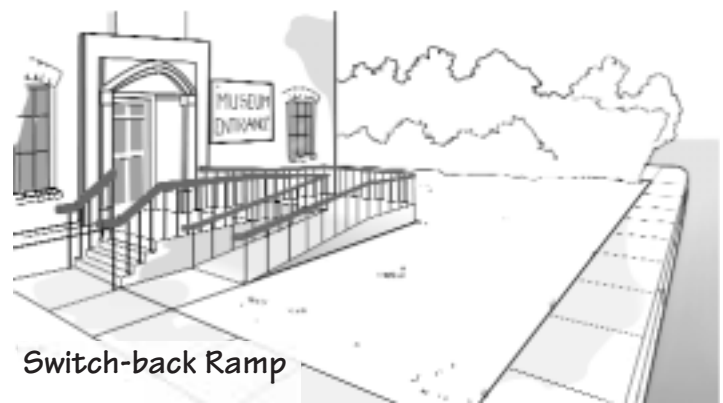

Switch-back Ramp



32" Minimum Clear Width Door

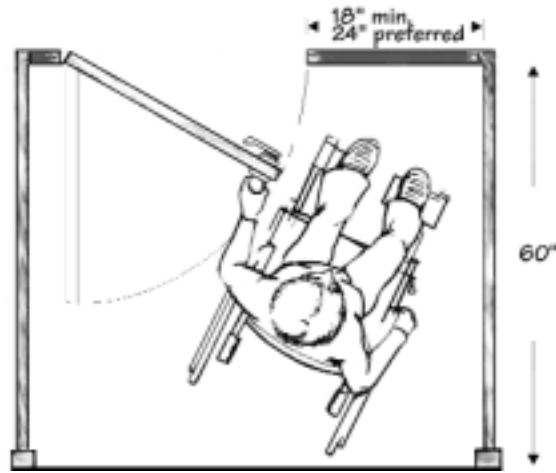

Clear Space to Side of Door



Sign at Inaccessible Entrance

Weather stripping on the bottom edge of the door is preferable to a threshold as a means of stopping infiltration. Thresholds must not be more than 1/2 inch high and must be beveled if more than 1/4 inch high. Interior doors should take no more than 5 pounds of pull (force) to open. Door closers should be adjusted or removed so that someone with limited upper body strength or limited mobility can easily open the door.

**Revolving Doors**

Many people with disabilities cannot use revolving doors or turnstiles. If either exists in a cultural facility, there must be a readily accessible alternate route around them. A swinging door placed immediately adjacent to a revolving door or a gate next to a turnstile are most convenient.

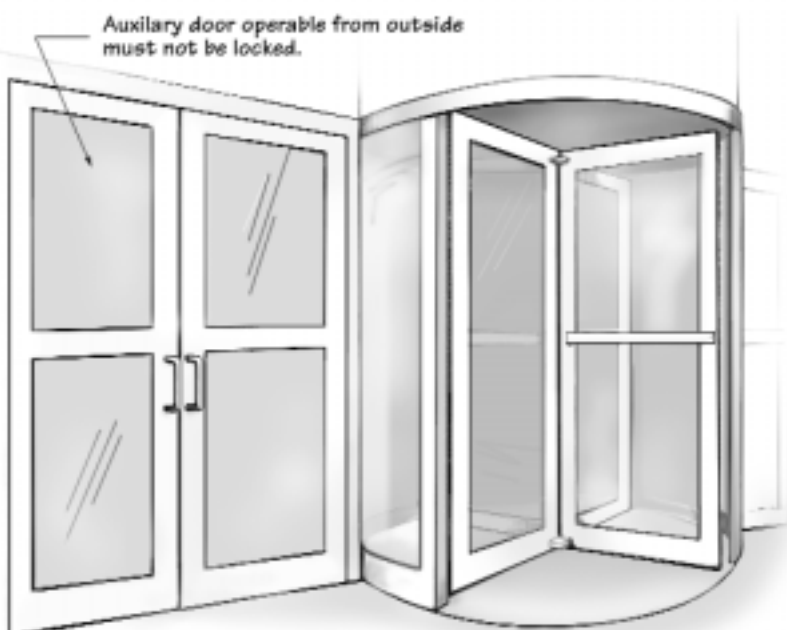

Auxiliary Entrance for Revolving Door

If a swinging door is not located near a revolving door, provide an alternate entrance. Post a sign at the revolving door directing people to the usable door. Proper signage, with the universal symbol for access, must be placed at any inaccessible entrance to notify the public where the closest accessible entrance is located.

### Power-Operated Door at Entrance

If swinging power-operated doors are used for two-way traffic, the activating and safety mats, as well as guard rails, must extend well in front of the door swing to prevent the opening door from hitting anyone. If the power door is operated with a button, be sure to place the button in an accessible location and out of the way of the swing of the door.



*Power Operated Door at Entrance*

### Double Door Vestibule

Double door vestibules with limited maneuvering space can trap people who use wheelchairs. At least 4 feet must be between the face of the first door and the second door in its open position. The best entrance for older adults and people with disabilities is one with power-operated doors.

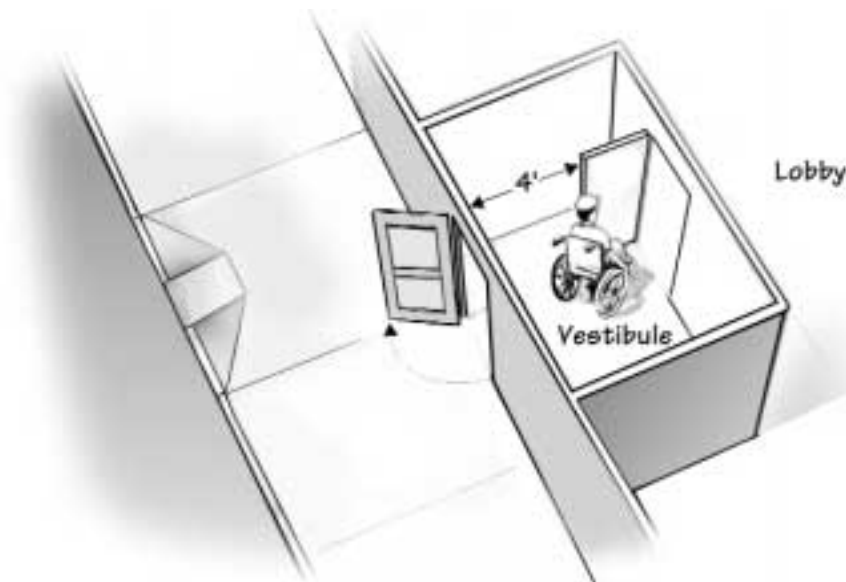

*Vestibule at Entrance*

## 4. Interior Accessible Route

Inside a building, people must be able to move about using a continuous pathway that is well lit, stable, firm, slip-resistant, unobstructed and at least 36 inches wide. The accessible route should be the shortest route. Signage should clearly mark the accessible route, if not all routes are accessible. If possible, seating should be provided at periodic intervals for people who need to rest.

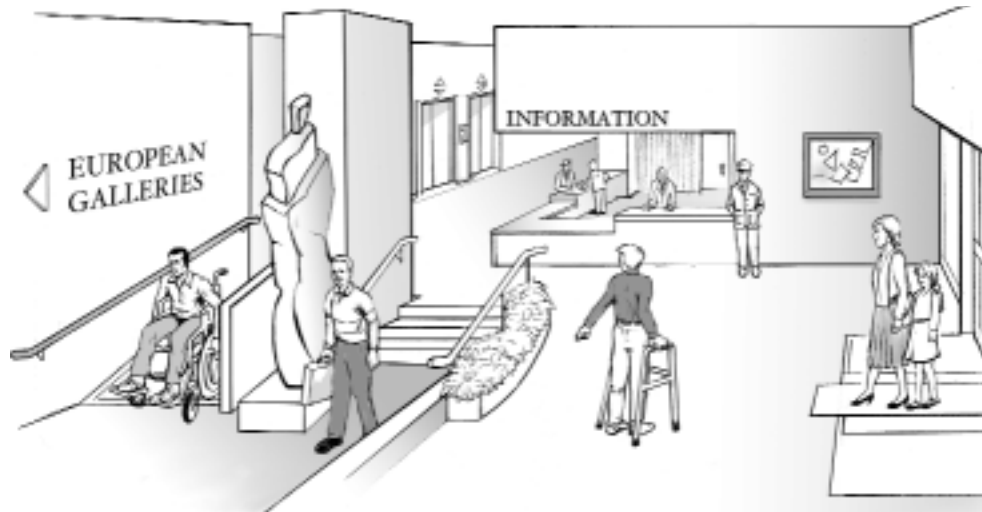

Interior Accessible Route

### Clearance for Passage

People who use mobility aids such as wheelchairs, walkers or crutches and braces require more space in which to maneuver. The average adult-sized wheelchair is about 26 to 28 inches wide and uses about 30 inches by 48 inches of floor space. Because at least four feet is required for a person in a wheelchair to pass a walking person—five feet for two people using wheelchairs to pass—it is recommended that all aisles and hallways have a minimum width of 5 feet.

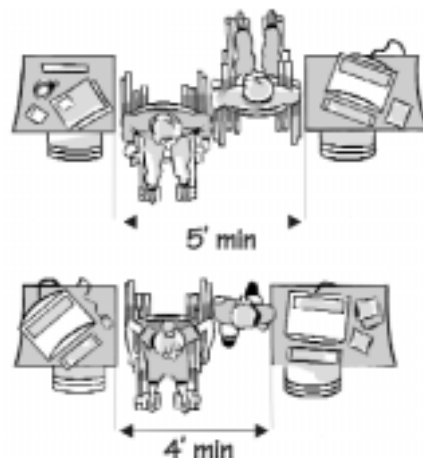

Clearance for Aisles

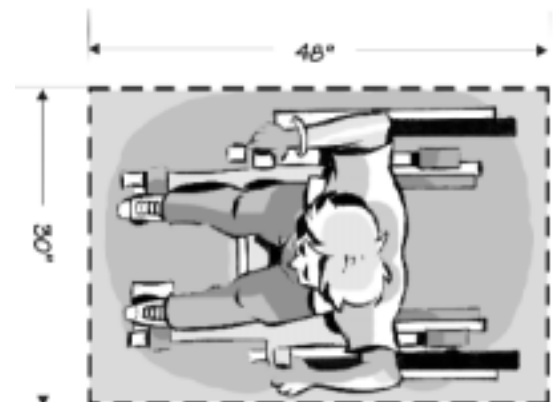

Clear Floor space



## Carpet

Carpet must adhere directly to the flooring, with a firm cushion, pad or backing that must be attached to the carpet. The carpet should be level loop, textured loop, level cut pile or level cut/uncut pile texture with a maximum pile thickness of 1/2 inch. Soft carpet or padding, especially in thicknesses greater than 1/2 inch, make using wheelchairs, crutches, canes and walkers very difficult. Any carpet that shifts, or has an unattached pad underneath, is very difficult for wheelchair users to negotiate.

## Protruding Objects

Wall-mounted elements such as telephone enclosures, light fixtures, fire extinguishers, water fountains, exhibit cases or signs that stick out more than four inches from the wall can be hazardous to people who are blind or have low vision and who depend on a long cane for mobility. If the cane passes below the object, the object is not detected, and people could walk into it.

There are several solutions: secure or extend a cane-detectable object under the protruding object; recess the object so it no longer protrudes; if possible, raise the object above 80 inches; or lower the protruding object to less than 27 inches so a person using a cane can detect it.

Problems can also result from handrails, cueing line barriers or objects with widely spaced supports. The latter can be imperceptible to those using a long cane because the cane can pass between or beneath them without making contact.

## Interior Changes in Levels

Abrupt changes in floor levels in buildings are one of the most common problems for people with disabilities. If one or more steps elevate an entire area, it is inaccessible and will need to be made accessible. Using wedges or small ramps can eliminate small changes in levels up to 6 inches in height.



Protruding Object Hazard

Protruding Object Warning



Stairwell with Cane Warning

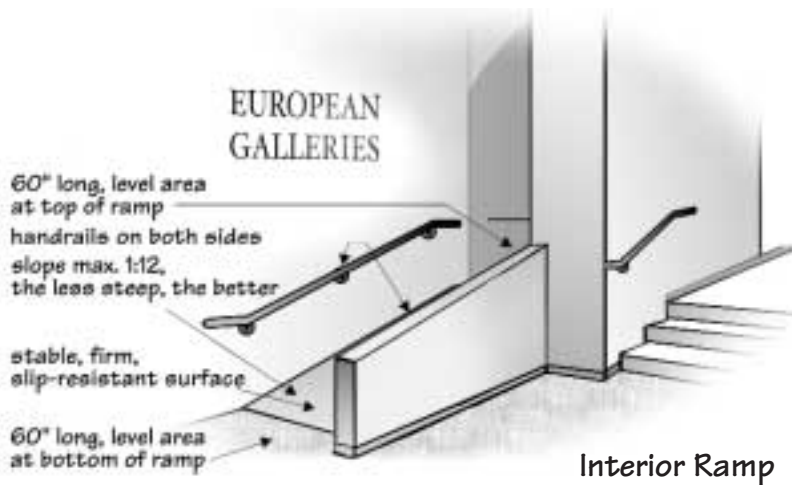

Interior Ramp

### Interior Ramps

The best and safest solution to an interior change in level is a permanent ramp. Finish material can match surrounding materials, but the ramp surface should be firm and have a non-slip surface. Such ramps must not be steeper than 1:12 and must have hand railings on both sides.

Remember, every foot of rise requires at least 12 feet of run. An intermediate 5-foot long landing or rest platform that is at least as wide as the ramp is

required for every 30 feet of run. In addition, 5-foot level platforms must be provided at both the top and bottom of the ramp. Extended lengthy ramps are a poor solution for the wheelchair user, because many people cannot push themselves up such a long slope.

### Intermittent/Temporary Ramps

For intermittent or temporary situations such as an outdoor art or music festival or a lecture/panel platform, use ramps with substantial handrails on each side and a non-slip surface. Portable metal ramps are another temporary solution. However, these folding lightweight ramps have small curbs, no handrails and should not be left in place unattended.



Handrail at Stairs

### Stairs

Handrails should be provided on both sides of stairs and around landings. Handrails must extend at least 1 foot horizontally beyond the top step and the bottom step. Hand railings should be 1 1/4 inches to 1 1/2 inches in diameter and be 1 1/2 inches from the wall. If handrails exist, but do not have horizontal extensions, modify or replace them. If horizontal extensions cannot be installed on both handrails, install them on at least one. If children will use stairs, consider installing a second, lower handrail.

### Elevators

If the building is equipped with elevators, the elevator may be completely accessible or may need some improvements to be usable by everyone.

**Elevator Lobbies**

Call buttons must be no more than 48 inches above the floor. Car arrival indicators should light up and ring to announce a car's arrival so people with either visual or hearing loss can perceive them.

Raised numeral and braille floor indicators must be placed on both doorjamb and located at a height of 60 inches above the floor. The raised numeral should be at least 2 inches tall and raised at least 1/16 of an inch above the surface. These can be easily added to elevator doorjamb.



Elevator Lobby

**Elevator Cab**

Elevator size is critical for people who use wheelchairs. Elevators should have enough space to allow a person using a wheelchair to turn around inside. If an elevator has at least a 30 inch by 48 inch clear floor space inside, it should accommodate a person using a wheelchair. By pulling straight in and backing out or vice versa, most people using wheelchairs can fit in an elevator that is as small as 48 inches from the door to the back wall. In these very small elevators, however, a person who uses a wheelchair will probably not be able to reach the controls unless the controls are placed on a side wall.

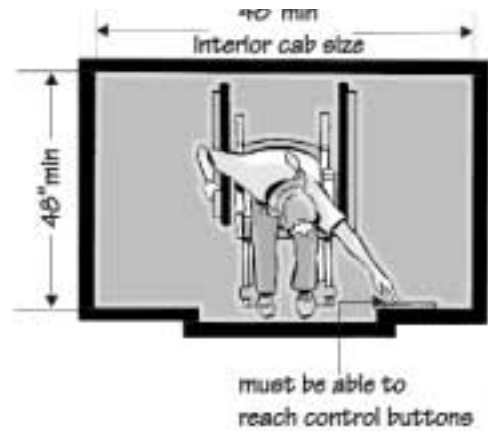

Minimum Cab Size

**Elevator Control Panel**

The highest operable part of the control panel (top elevator control button and/or the emergency controls) must be no more than 48 inches above the floor. In some cases, it may be acceptable to install a stick or wand hung from a chain in the corner of the cab that can be used to push controls that are out of reach.

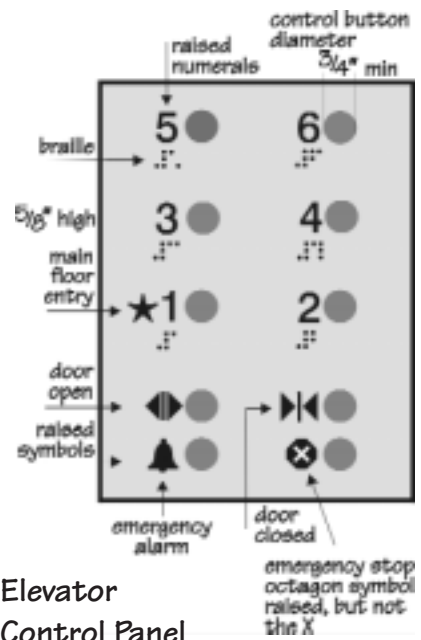

Elevator Control Panel

Elevator control buttons must have raised numerals and braille to the left of each button. Inexpensive, adhesive-backed, raised numerals with braille can be added to existing elevator panels. However, these labels are easily removed and must be continually monitored to ensure that they remain in place. For people who are blind or have low vision, lighting is also particularly important, as are the size and contrast of color on the call buttons.

### Lifts

Mechanical wheelchair lifts are a solution of last-resort. Lifts require power, are subject to mechanical failure and operator error, need routine and regular maintenance, require the use of a key and have several built-in safety features that make them difficult to use independently in public spaces. Wheelchair lifts should only be installed if there is not adequate room for a ramp or another solution is not available. Post instructions for operation on or near the lift and have the key readily available.

Mechanical lifts can be placed over or next to existing stairs. Two types of lifts exist, vertical and inclined. Vertical lifts are placed at or beside the stairs and rise or lower vertically. Inclined lifts travel on a track mounted on the wall beside the stair. Most inclined lifts can be folded out of the way when not in use. Many jurisdictions restrict them from use on narrow flights of stairs where they may block fire egress.

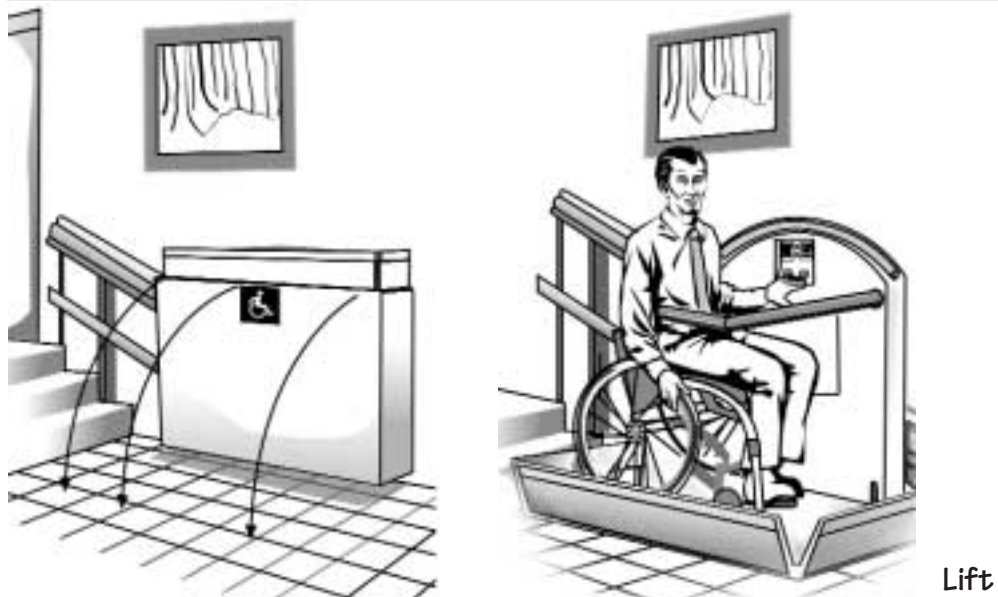

## 5. Amenities, Services and Conveniences

People with disabilities must be able to take advantage of food services, shops, and other amenities and conveniences. Accessibility goes beyond the ability to just enter and exit an area, space or room. It also means the ability to use the facilities or take advantage of the services provided.

**Controls and Hardware**

Controls and hardware include operating mechanisms such as door handles, thermostats, toilet flush controls, faucet handles, locks, dial pads, window cranks, computer keyboards and touch screens, fire alarms, light switches and coin slots. They must be mounted where short or seated people or those who cannot raise their arms can reach them. There has to be enough clear floor space for people using wheelchairs to get close to the controls. In addition, controls must be easy to operate. Controls should be operable with one hand in a closed fist and not require gripping, twisting nor more than five pounds of pressure.



Rocker Switch

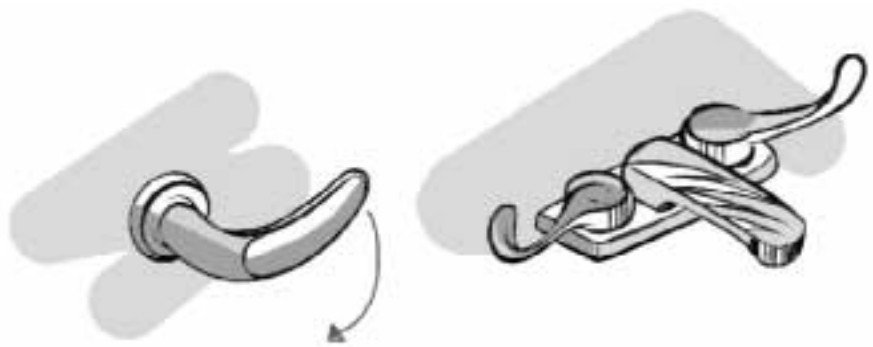

Lever handles

**Reach Ranges**

People with disabilities who are of short stature or who use wheelchairs cannot easily reach objects or controls placed higher than 48 inches above the floor. The most usable range is between 36 and 48 inches above the floor.

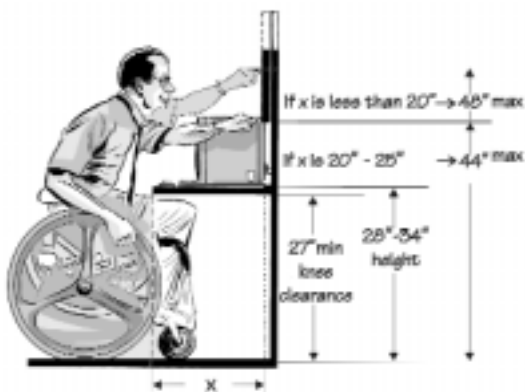

Forward Reach Range at Work Surface

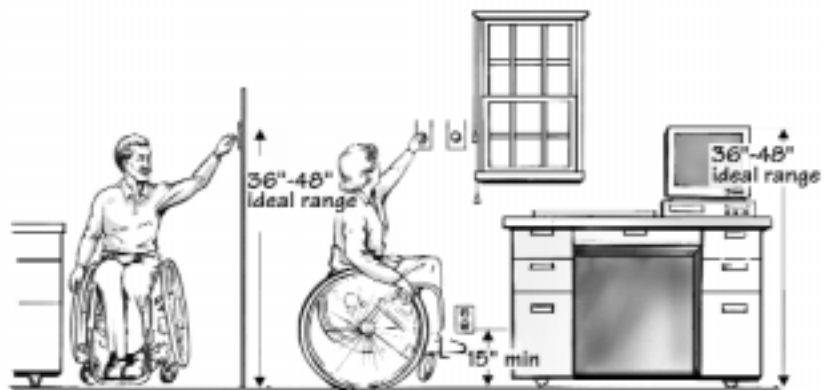

Side Reach Range



Accessible Pay Telephone

### Telephones

Public telephones should be mounted along an accessible route (not protruding) with the highest operable part (coin slot or keypad) no more than 48 inches above the floor. Clear floor space of at least 30 by 48 inches must be in front of the phone so that a person using a wheelchair can comfortably pull up to it.

At least one phone in each phone bank should have volume control for people who are hard-of-hearing. If public pay phones are made available, then a TTY for public use should also be available. Place signage at public phones to indicate the availability of volume controls and the location of the nearest TTY.

### Water Fountains

Water fountains should be located along an accessible route and can be used by most people with disabilities, if the spout is no more than 36 inches above the floor.

The best type of water fountain for people who use wheelchairs is one that has at least 27 inches of clear space between the bottom of the apron and the floor. A high-low arrangement of water fountains is accessible to standing, seated or short individuals. Water fountains with automatic or lever-type handles are best because wheelchair users cannot use foot-operated controls. Installing a new lower water fountain may be more economical than relocating or modifying an existing installation.



Minimum Apron Clearance



Maximum Spout Height



Hi-Low Fountains

## Signage

Signs that designate permanent rooms and spaces such as restrooms, conference or meeting rooms and offices must be accessible. In general, accessible signs have raised letters and numerals, use sans serif type and braille. Typeface must be clear, with maximum contrasting colors. The surface of the sign should be well lit and have a matte or other non-glossy finish.

Signage is a much overlooked accessibility asset. It should be used to give people information and direct them to accessible routes and entrances, telephones, restrooms and emergency exits (especially when not all are accessible). Most people, including those who cannot read or do not know English, can understand pictographs and international symbols.

## Warning Signals

Emergency warning systems should produce signals that can be perceived by people who are blind or have low vision and those who are deaf or hard-of-hearing. Signals that are exclusively bells, buzzers, flashing lights or visual warning signs are useless to people who cannot hear or see them.

Many new electronic devices provide warning signals that are both audible and visible. If ringing bells are used, for example, to signal patrons and visitors of the start of a movie or performance, the arrival of transportation or the start of a demonstration, make sure to have some visual alert such as flashing lights.

## Ticket Offices and Information Booths

Ticket offices and information booths should be located on accessible routes and have a minimum clear space of 30 by 48 inches in front of the transaction window or counter. A 60 by 60 inch clear floor area is preferable so that someone using a wheelchair, scooter or walker can approach and turn around to leave rather than having to back away.

At least one counter and/or window should be a maximum of 36 inches above the floor with knee space that is at least 27 inches high and at least 36 inches wide so that a person who is seated or short can approach the transaction space. At this level a short or seated user can see and communicate easily with the person behind the counter. It will also allow the person to use the counter space to write checks or make transactions. If stanchions or other crowd-control devices are used to organize lines, be sure these are placed so that the path is at least 36 inches wide at all points.

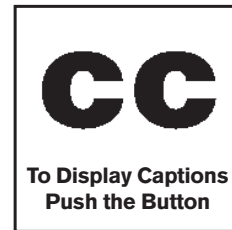

Readable Sign



Pictograph



Audible and Visible Signals



Ticket Office Window



Information Counter

Locate ticket offices and information booths in areas that are acoustically protected so that patrons are able to hear the person selling tickets or providing information. These areas also should be well lit to allow patrons who have low vision to see seating charts, tickets, maps, brochures and receipts. Signage should be clear and legible with large simple fonts in high contrast colors.

### Coatrooms

The counter at the coatroom should be no higher than 36 inches so that a short or seated person can easily pass heavy coats and bags to the attendant. If the coatroom is self-service, at least one rack or section of hangers and coat hooks should be no higher than 48 inches.



### Concessions and Food Service

Seating for individuals who use wheelchairs or other mobility aids should be integrated and dispersed throughout restaurants, dining rooms, canteens and cafeterias. At least five percent of the tables must be accessible. Aisles and space between tables should be at least 36 inches wide to allow people to easily maneuver between the tables and chairs—even when people are seated at the tables.

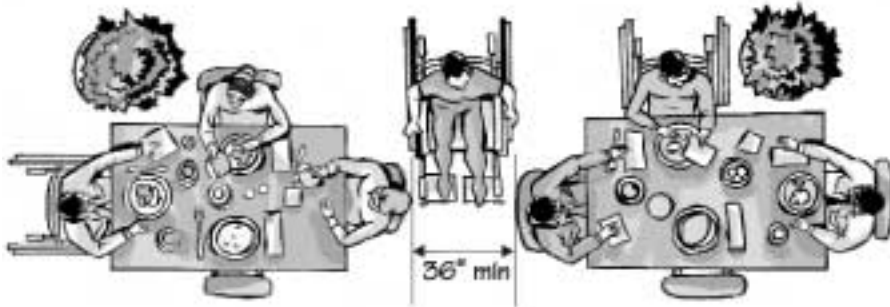

*Restaurant Seating*

People using wheelchairs must be able to get their knees under the table. This requires clearance that is at least 27 inches high, 30 inches wide and 17 inches deep under accessible tables and counters. The tops of accessible tables and counters should be no higher than 34 inches above the floor.

Provide menus in accessible formats such as large print and braille, or prepare waiters to read the menu to diners who are blind, have low vision or difficulty reading text materials. People who are deaf or hard-of-hearing appreciate well lit and quiet dining areas.

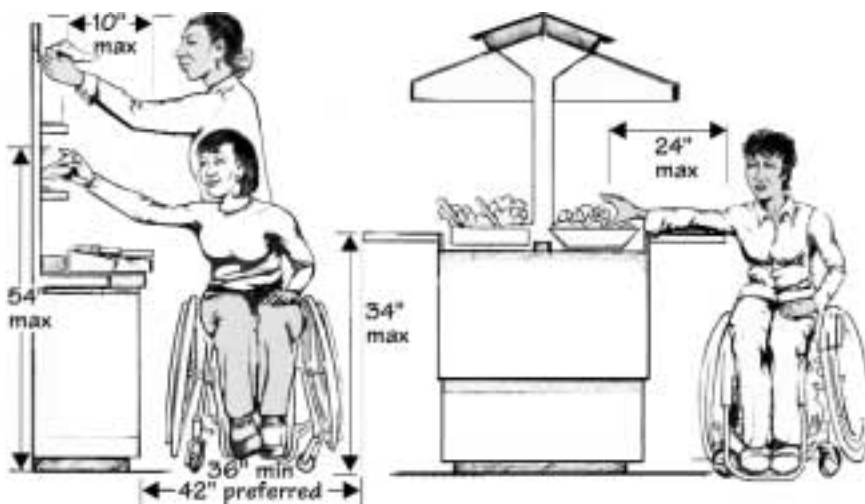

*Food Service Area*



Gift Shop

**Shops**

Make gift shops accessible with good lighting, wide aisles and easy to reach items.

Keep aisles at least 36 inches wide. Placing displays and allowing merchandise to protrude into the aisles makes it difficult, uncomfortable and potentially unsafe for people with different mobility aids, as well as for those who are blind or have low vision, to maneuver around the shop. Train staff to assist customers in retrieving

objects that are displayed out of reach and to read prices to those who cannot read text.

Make at least one cash register and counter accessible to people who are short or use a wheelchair. The counter top should be no more than 36 inches above the floor, at least 36 inches in length and placed along an accessible route.

**6. Restrooms**

Accessible restroom facilities may have many different configurations. Single user restrooms are convenient for individuals who use power wheelchairs or scooters or who need assistance with personal care. These single-user (unisex) restrooms are also very useful for parents who need to assist children.

Circular Clear Floor Space

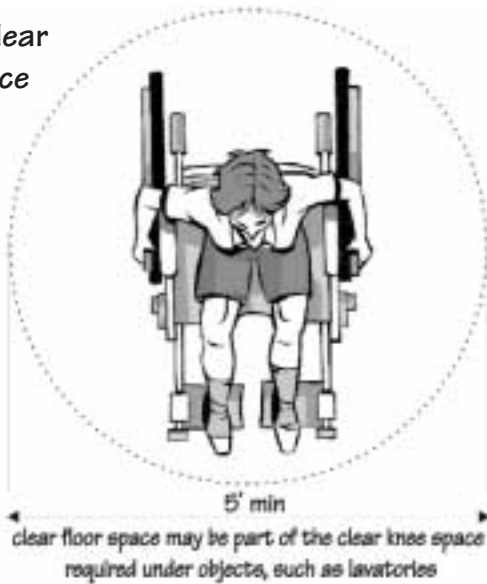

T-shaped Clear Floor Space

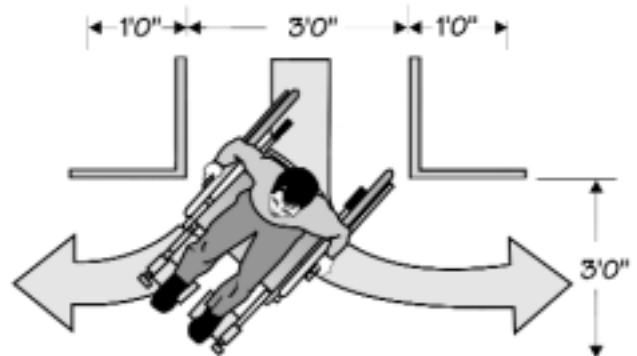

### Restroom Signage, Doors and Vestibules

Signage at restrooms must have raised characters, braille and pictograms. Signs must be located on the wall at the latch side of the door whenever possible and be hung 60 inches from the center point of the sign to the floor. Signs should indicate whether the restroom is for men, women or unisex and whether the restroom is accessible. If the restroom is not accessible, signage must be provided that directs people to the nearest accessible restroom.

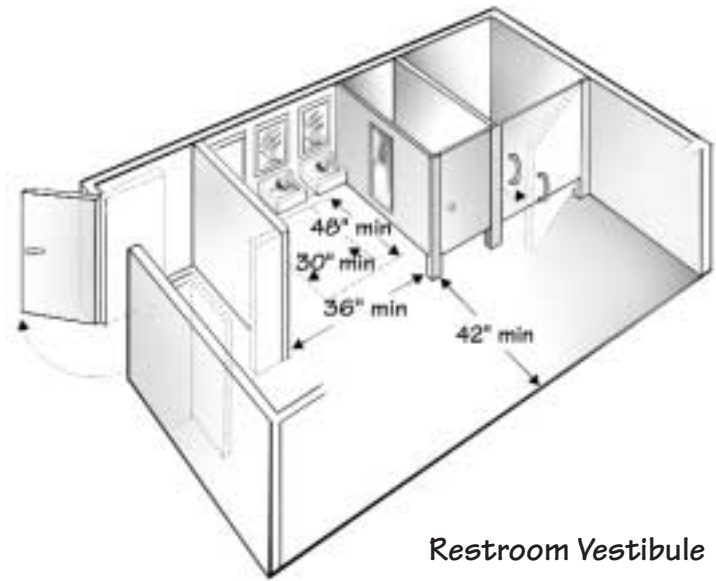

Restroom Vestibule

Doors to be used by people with disabilities must provide a 32-inch clear opening width when the door is in the open position. Some restrooms have a vestibule or an entrance that requires people to turn a sharp corner. These and double-door vestibules with limited maneuvering space can trap people who use mobility aids.

There must be at least 4 feet between the vestibule's second door in its open position and the face of the first door. Entrances that wrap or turn corners should be wide enough to allow a person using a scooter or larger power wheelchair to comfortably turn and maneuver into the restroom.

### Toilet Stalls

Every restroom should have at least one accessible stall that has a 60-inch diameter or T-turn clear floor space free of the door swing. The toilet should be located in the corner diagonally opposite from the door. This space configuration allows a wheelchair user to do a side transfer onto the toilet, and turn around inside the stall. Accessible toilet stalls must have doors that, when open, have a clear opening width of 32 inches. This usually means that the door itself will be at least 33 inches wide. Inside the stall there should be two 1 1/2 inch diameter grab bars mounted

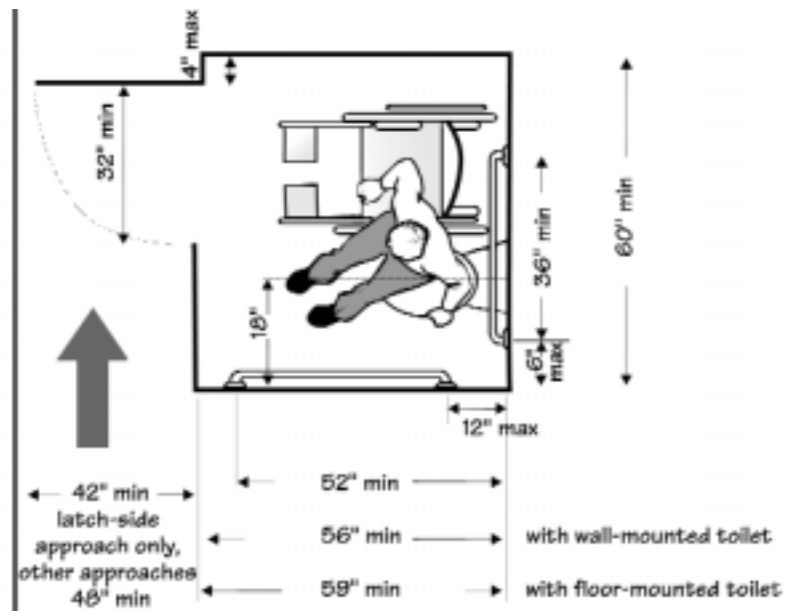

Accessible Toilet Stall

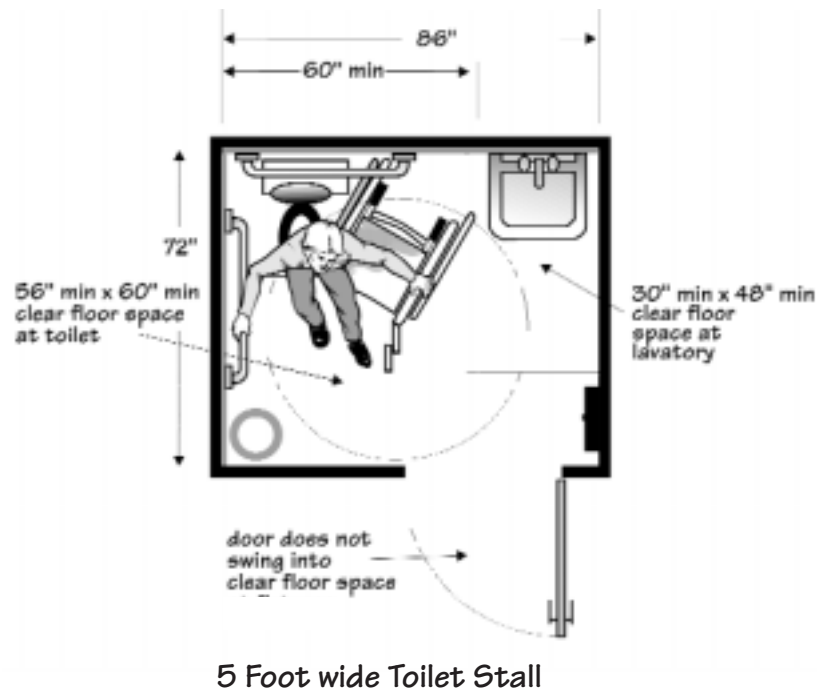
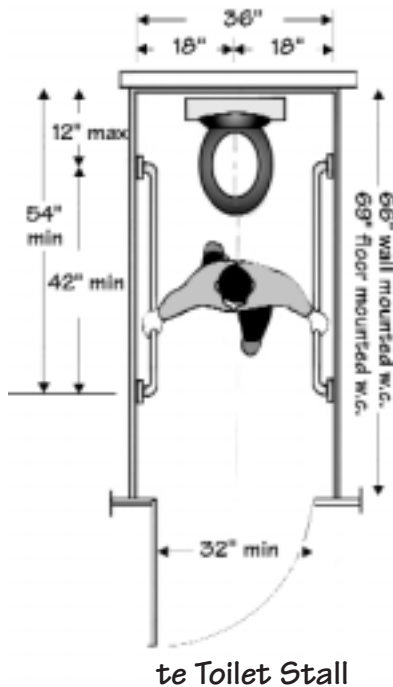

horizontally, with a 42-inch bar on the near wall and another 36-inch bar on the rear wall, both at a height of 33 inches above the floor. The space between the grab bars and the wall should be exactly 1 1/2 inches wide. The top of the toilet seat in the down position should be between 17 and 19 inches from the floor.

Toilet paper dispensers should allow for a continuous flow of paper and be located in a position below the grab bars that is easy to reach while seated at the toilet. Recessed dispensers are preferred but not required. Stall doors should have locks and handles that can be operated easily with a closed fist. Coat hooks, dispensers and trash receptacles should be located within reach range no lower than 15 inches and no higher than 48 inches from the floor.

### **Lavatories, Mirrors, Soap and Towel Dispensers**

Lavatories used by people with disabilities must have at least 29 inches of clearance between the bottom edge of the apron front and the floor. The faucets should be automatic or have handles that can be operated without grasping and twisting. Levers and push buttons (the kind that require light pressure and leave the water running for a while) are generally preferred. Pipes under the lavatory must be insulated to protect people who have no sensation in their legs from burning.

Mirrors must have bottom-reflecting edges no more than 40 inches above the floor. Dispensers and trash receptacles should have the highest operable part no more than 48 inches above the floor. Do not locate them so the wheelchair approach is obstructed. Following are some suggestions for modifications:

- Cut lavatory aprons to provide necessary knee clearances.
- If dispensers and mirrors are too high, it is often easier to mount a new dispenser nearby and install a full-length mirror on another wall than to relocate the existing ones.
- If towel and soap dispensers are too high, place towels and soap on the lavatory counter or on a shelf or table within reach of seated or short people. Remember, however that doing this requires daily maintenance.
- Replace round faucet knobs with automatic controls or with lever handles that can be operated with a closed fist.

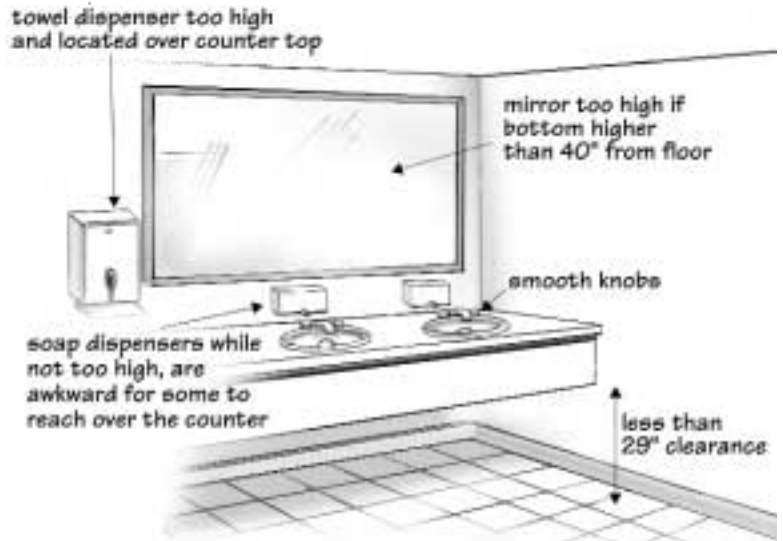

Problem at Lavatories

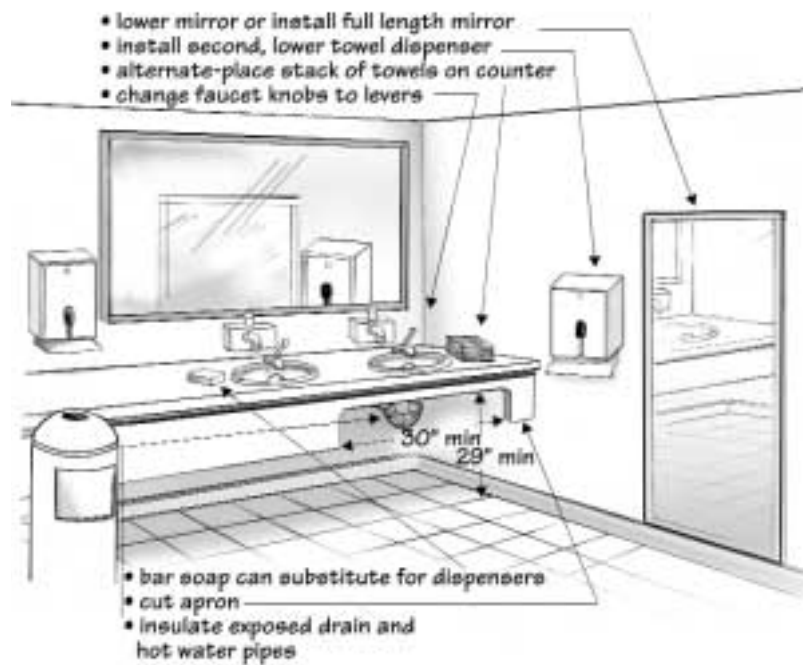

Modified Lavatory

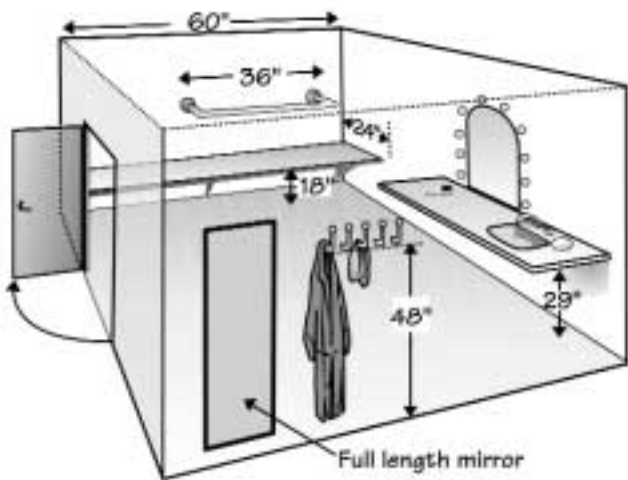

Work Areas - Dressing Room

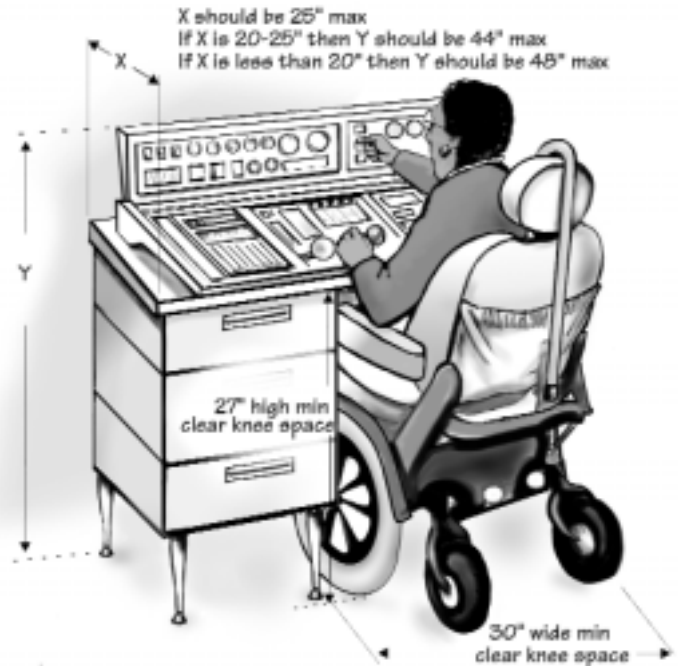

Work Areas - Control Booth

## 7. Work Areas

Be prepared to provide reasonable accommodations to make work areas accessible to staff, board members, panelists, volunteers, performers, technicians and others with disabilities. Work areas should be clear of protruding objects. Aisles and passageways should be kept unobstructed, well lit and safe for individuals who are blind or have low vision. A person who uses a wheelchair or other mobility aid should be able to get comfortably into and out of work areas and be able to use and reach workstations, operate equipment, use the restrooms and take advantage of break rooms, lounges and cafeterias.

## **RESOURCES**

### **UNIVERSAL DESIGN**

#### **The Center for Universal Design**

North Carolina State University  
College of Design  
Campus Box 8613  
Raleigh, NC 27695-8613  
(919) 515-8359 voice/TTY  
(919) 515-8951 fax  
cud@ncsu.edu  
www.design.ncsu.edu/cud

#### **“Global Universal Design Educators Monthly On-Line News”**

Institute for Human Centered Design (Adaptive Environments)  
200 Portland Street  
Boston, MA 02114  
(617) 695-1225 voice/TTY  
(617) 482-8099 fax  
info@humancentereddesign.org  
www.adaptenv.org/global

#### **Center for Inclusive Design & Environmental Access**

378 Hayes Hall, School of Architecture and Planning  
University at Buffalo  
Buffalo, NY 14214-3087  
(716) 829-5902 voice  
(716) 829-3861 fax  
ap-idea@buffalo.edu  
www.ap.buffalo.edu/idea

#### **Universal Design Selected Bibliography**

Institute of Human Centered Design  
200 Portland Street, Suite 1  
Boston, MA 02114  
(617) 695-1225 voice/TTY  
(617) 482-8099 fax  
www.adaptenv.org

## SURVEYS AND CHECKLISTS FOR ACCESSIBILITY

### **“Readily Achievable Checklist: A Survey for Accessibility”**

Institute for Human Centered Design (Adaptive Environments)

200 Portland Street

Boston, MA 02114

(617) 695-1225 voice/TTY

(617) 482-8099 fax

info@humancentereddesign.org

www.adaptenv.org

### **“ADA Compliance Guidebook: A Checklist for Your Building”**

Building Owners and Managers Association International

1101 15th Street NW, Suite 800

Washington, D.C. 20005

(202) 408-2662 voice

(202) 326-6377 fax

<http://shop.boma.org/showItem.aspx?product=SE044ADA&session=09F96DC8A5A7483FA981A9EBAFBBFFE3>

### **“Checklist For Buildings And Facilities”**

Access Board

1331 F Street NW, Suite 1000

Washington, D.C. 20004-1111

(800) 872-2253 voice

(800) 993-2822 TTY

(202) 272-0081 fax

info@access-board.gov

[www.access-board.gov/adaag/checklist/a16.html](http://www.access-board.gov/adaag/checklist/a16.html)







photo by Leslie Young, Center for Universal Design

North Carolina Museum of History, Raleigh, NC: Visitor Maralo Guimaraes and ramp

## CHAPTER 4

# Architectural Access to Historic Properties

This chapter is excerpted with permission from “Making Historic Properties Accessible,” Preservation Brief 32 by Thomas C. Jester, architectural historian, and Sharon C. Park, AIA, senior historical architect, Preservation Assistance Division of the National Park Service. Download the complete brief at [www.nps.gov/history/hps/tps/briefs/brief32.htm](http://www.nps.gov/history/hps/tps/briefs/brief32.htm)

Historic properties are irreplaceable and require special care to ensure their preservation for future generations. With the passage of the Americans with Disabilities Act, access to historic properties open to the public is now a civil right and owners of historic properties must evaluate existing buildings to determine how they can be made more accessible. It is a challenge to evaluate properties thoroughly, to identify the applicable accessibility requirements, to explore alternatives and to implement solutions that both provide independent access and are consistent with accepted historic preservation standards.

This chapter introduces historic property owners, design professionals and administrators to the issues of evaluating historic properties to provide the highest level of accessibility while minimizing changes to historic materials and features. Because many projects encompassing accessibility work are complex, consultation with experts in the fields of historic preservation and accessibility is advisable before proceeding with permanent physical changes to historic properties.

**“Preservation of our historic structures; presentation of an early 19th century community complete with earthen paths and roadways and narrow entries with stone steps provided a challenge of the greatest magnitude. With the assistance of our Accessibility Advisory Council, however, we found our successes in adopting the broadest perspective while developing solutions. Operationally, it had to become a way of thinking for all of us, if we were to achieve our goals for an accessible environment.”**

Alberta Sebolt-George, President and CEO, Old Sturbridge Village  
(1971-2002)

Solutions for accessibility should not destroy a property's significant materials, features and spaces, but should increase accessibility as much as possible. Remember, most historic buildings are not exempt from providing accessibility. With careful planning, owners can make historic properties more accessible, so that all people can enjoy their significance.

Historic properties are not exempt from the ADA Accessibility Guidelines (ADAAG). The ADA requires barrier removal in historic buildings, if the removal is readily achievable. The ADA, however, takes into account the national interest in preserving significant historic structures. Barrier removal would not be considered "readily achievable," if it would threaten or destroy the historic significance of a building or facility that is eligible for listing in the National Register of Historic Places under the National Historic Preservation Act (16 U.S.C. 470, et seq.), or is designated as historic under state or local law.

## **Planning Accessibility Modifications**

Features, materials, spaces and spatial relationships that contribute to historic character, distinguish historic properties. Often these elements, such as steep terrain, monumental steps, narrow or heavy doors, decorative ornamental hardware, narrow pathways and corridors, pose barriers to people with disabilities or who are older, particularly to people who use wheelchairs or have limited mobility.

### **Three Steps to Accessibility**

Use a three-step approach to identify and implement accessibility modifications that protect the integrity and historic character of historic properties:

First: Review the historical significance of the property and identify character-defining features.

Second: Assess the property's existing and required level of accessibility.

Third: Evaluate accessibility options within a preservation context.

#### **1. Review the Historical Significance of the Property**

If the property has been designated as historic (properties in or eligible for listing in the National Register of Historic Places, or designated as such under state or local law), review its nomination file to learn about its significance. Supplement the documentation review with physical investigation to identify which character-defining features and spaces must be modified.

Also, identify secondary spaces, finishes and features of less importance to the historic character; these generally may be altered without jeopardizing the property's historical significance. It is often possible to modify non-significant spaces, secondary pathways, later additions, previously altered areas, utilitarian spaces and service areas without threatening or destroying a property's historical significance.

## **2. Assess the Property's Existing and Required Level of Accessibility**

A building survey or assessment provides a thorough evaluation of a property's accessibility. People with disabilities should be included in building assessments. Such surveys or assessments should identify accessibility barriers including, but not limited to: building and site entrances, ramp and walkway surface textures, widths and slopes of ramps and walkways, parking, grade changes, size and weight of doors, configuration of doorways, interior corridors and path of travel restrictions, elevators, public restrooms and amenities.

Review all applicable accessibility requirements—state codes, local codes and federal laws—before undertaking any accessibility modification. Many states and localities have their own accessibility regulations and codes (each with its own requirements for dimensions and technical requirements). Use the most stringent accessibility requirements when implementing modifications.

## **3. Identify and Evaluate Accessibility Options within a Preservation Context**

Once owners have identified a property's significant materials and features and established both existing and required levels of accessibility, solutions can be developed. Solutions should provide the greatest accessibility without threatening or destroying the materials and features that make a property significant. All proposed changes should conform to the Department of the Interior's "Standards for the Treatment of Historic Properties," which was created to guide property owners' preservation work.

Owners may phase in modifications over time and can consider interim solutions. A team comprising older adults and people with disabilities,

**“Accessibility and respect for the integrity of historic sites are important priorities. We had always dealt with these as separate issues until our recent renovation of Charleston’s 1836 MacFarland-Hubbard House, when suddenly, both were at the top of the agenda. Working with a dedicated team we found surprisingly simple solutions to creating accessibility by raising a back porch floor and re-grading the surrounding yard to create an effectively invisible wheelchair ramp.”**

Ken Sullivan, Executive Director, West Virginia Humanities Council

accessibility and historic preservation professionals and building inspectors should consult on the development of accessibility solutions.

### **Priorities for Modifications to Improve Accessibility**

First: Make accessible the main or a prominent public entrance and primary public spaces, including a path to the entrance.

Second: Provide access to goods, services and programs.

Third: Provide accessible restroom facilities.

Fourth: Create access to amenities, secondary spaces and emergency egress.

### **Accessibility Solutions**

The goal in selecting appropriate solutions for specific historic properties is to provide a high level of accessibility without compromising significant features or the overall character of the property. Consider all of the historic property's components.



Primary Public Entrance

### **Entrances**

Access to historic buildings should be through a primary public entrance. If this cannot be achieved without permanent damage to character-defining features, the owner should make at least one entrance used by the public accessible. Directional signs at all inaccessible entrances should direct visitors to the accessible entrance.

Possible modifications to create an accessible entrance include re-grading an entrance, incorporating ramps, retrofitting doors, altering door thresholds, adapting door hardware, converting an existing window to a new entrance or, as a last resort, installing wheelchair lifts.



Entrance with Re-graded Landscape

### Historic Interiors

Primary spaces are often more difficult to modify without changing their character. Generally, secondary spaces may be changed without compromising a building's historic character. Signs should clearly mark the route to accessible restrooms, telephones and other accessible areas. Some modifications that may help create access to interior spaces without changing their character include installing ramps, upgrading elevators, modifying interior stairs and retrofitting doorknobs.

### Building Amenities

Some amenities, such as restrooms, seating, telephones, water fountains and counters may contribute to a building's historic character. They often will require modification to improve their use by people with disabilities. In many cases, supplementing existing amenities, rather than changing or removing them, will increase access and minimize changes to historic features and materials.

### New Additions

New additions create opportunities to provide access for older people and individuals with disabilities by incorporating modern amenities such as accessible entrances, elevators, ramps, restrooms, food service areas and gift shops. Consider the location carefully so that it is near parking and connected to an accessible route. New additions can increase accessibility and reduce the level of change to historic features, materials and spaces.



New Addition

### Programmatic Access

“Programmatic access” for historic properties refers to alternative methods of providing services, information and experiences when physical access cannot be provided. It may mean offering an audio-visual program or computerized virtual tour showing an inaccessible upper floor of an historic house museum, providing interpretive panels from a vista or overlook at a terraced garden or creating a tactile model of a historic monument for people who are blind or have low vision.

## **Making Historic Landscapes Accessible**

The planning process for incorporating access into historic landscapes is similar to that of other historic properties. Undertake careful research and inventory to determine which materials and features convey the landscape's historic significance. Identify features that are character defining, such as topographical variation, vegetation, circulation, structures, furnishings and objects.

Document and evaluate historic finishes, details and materials that contribute to a landscape's significance before determining an approach to landscape accessibility. For example, understand all aspects of the pedestrian circulation system including walk width, aggregate size, pavement pattern, texture, relief and joint details. Note the context of the walk, including its edges and surrounding area.

Additionally, identify areas of secondary importance, such as altered paths—especially those where the accessibility modifications will not destroy a landscape's significance. Identifying those features that do or do not contribute to accessibility is essential in developing a sympathetic circulation pattern.

After assessing a landscape's integrity, consider accessibility solutions. When a landscape is uniformly steep it may be possible to make discrete portions of the historic landscape accessible. For example, viewers may experience the landscape from selected vantage points along a prescribed pedestrian or vehicular access route. Define this route by considering the interpretive value of the user's experience: does the route provide physical or visual access to areas that are critical to understanding the meaning of the landscape?



## RESOURCES

### ACCESSIBILITY AND HISTORIC PROPERTIES

#### **“Comply with Accessibility Requirements”**

Whole Building Design Guide, National Institute of Building Sciences  
(NIBS)

1090 Vermont Avenue NW, Suite 700

Washington, D.C. 20005

(202) 289-7800 voice

(202) 289-1092 fax

[www.wbdg.org/design/comply\\_requirements.php](http://www.wbdg.org/design/comply_requirements.php)

#### **“Preserving the Past and Making it Accessible for People with Disabilities”**

[www.nps.gov/hps/freepubs.htm](http://www.nps.gov/hps/freepubs.htm)

#### **“Preservation Brief 32: Making Historic Properties Accessible”**

[www.nps.gov/history/hps/tps/briefs/brief32.htm](http://www.nps.gov/history/hps/tps/briefs/brief32.htm)

#### **“Secretary of the Interior’s Standards for the Treatment of Historic Properties”**

[www.nps.gov/history/hps/tps/standguide/](http://www.nps.gov/history/hps/tps/standguide/)

Heritage Preservation Services, National Park Service

1849 C Street NW, (2255)

Washington, D.C. 20240

(202) 513-7270 voice

[NPS\\_HPS-info@nps.gov](mailto:NPS_HPS-info@nps.gov)

[www.nps.gov/hps](http://www.nps.gov/hps)

## **PARKS, RECREATIONAL AND OUTDOOR FACILITIES**

### **National Center on Accessibility**

Provides technical assistance on design and retrofitting leisure areas and park facilities.

Indiana University Research Park

501 North Morton Street, Suite 109

Bloomington, IN 47404

(812) 856-4422 voice

(812) 856-4421 TTY

(812) 856-4480 fax

[nca@indiana.edu](mailto:nca@indiana.edu)

[www.ncaonline.org](http://www.ncaonline.org)

### **“Forest Service Outdoor Recreation Accessibility Guidelines”**

USDA Forest Service

Accessibility Program

1400 Independence Avenue SW

Washington, D.C. 20250-0003

(800) 832-1355 voice

[info@fs.fed.us](mailto:info@fs.fed.us)

[www.fs.fed.us/recreation/programs/accessibility/](http://www.fs.fed.us/recreation/programs/accessibility/)





photo by Jerry Dalia

Paper Mill Playhouse, Millburn, NJ: Sign language interpreter Jolinda Greenfield for "Dreamgirls"

# Effective Communication and Program Access

## Five Steps to Effective Communication

This chapter looks at auxiliary aids and services that provide effective communication and make programs inclusive, enjoyable and accessible to everyone.

In addition to physical access to programs, arts and humanities organizations must provide access to the content of their programs for audiences, instructors, artists, interns, participants, staff, docents, visitors, patrons and volunteers. Everything the organization produces or presents must be accessible, including exhibitions, lectures, films, videos, interactive computer displays, plays and concerts, as well as the materials about the programs—catalogues, labeling, scripts, libretti, brochures, maps and publicity.

Effective communication allows people with disabilities that affect their hearing, vision, speech and cognition to participate in services, goods and programs. Auxiliary aids and services include a wide range of communication techniques and devices.

Keep in mind the five steps to achieve effective communication:

First: Understand that there is no “one-size-fits-all” solution.

Second: Explore ways to accommodate the diverse needs of each population.

Third: Be prepared with well thought-out policies and procedures for accommodating the diverse needs of each population.

Fourth: Train all staff and volunteers who come in contact with the public to be knowledgeable about auxiliary aids and services.

Fifth: Inform the public about auxiliary aids and services through signage, advertising, Web sites and other means available.

## For People Who Are Blind or Have Low Vision

Information regularly provided in visual formats must also be available in alternate formats. The “blind community” is not one large homogeneous group. People who are blind, legally blind or have low vision have a range of sight and loss of sight. Some people are blind from birth while others become blind later. People may have reduced or limited vision because of loss of visual acuity as they age. This diversity is reflected in the variety of possible ways to make visual information accessible.



Audio Describer  
in Booth

Patron Using  
Audio Description

### Audio and Video Description

Audio description and descriptive video provide concise, objective descriptions of the settings, costumes, action, physical appearance and body language of the characters in a play, film, video or television program or the size, shape, colors, textures, composition, subject and content of visual art or other exhibited materials.

Describers undergo extensive training to attain proficiency. Not everyone has the skills or qualities to be a good describer. For example, describers



are trained to slip descriptions in-between lines of dialogue. They also avoid qualitative judgments. A well-trained describer would not say, “He is angry,” or “She is sad.” Rather, they would say, “He’s clenching his fist,” or “She is crying.”

- Audio description for performances and tours is usually delivered live and transmitted to listeners via infrared or FM assistive listening devices.
- Audio description for museums and exhibits is usually pre-recorded and available to visitors on audiocassette or via random access digital playback systems.
- Video description is pre-recorded and, in the case of recorded television programs, videotapes and DVDs (Digital Video Discs), is available on television with a SAP (second audio program). Broadcasts of live events, such as parades, are described live. Description for films can be recorded or delivered live.

## Audio Alternatives for Print

Some people who are blind or have low vision cannot read braille or large print and find recorded information more useful. Also instances exist where some people with motor impairments or learning disabilities cannot use traditional print and prefer hearing information rather than reading it. A braille or large print version of label text might be too cumbersome to carry around a historical exhibit.

Text information can be provided via audiocassette tapes and other technologies such as random access digital playback systems or FM/infrared systems. In museums and exhibitions, locate listening stations with speakers, handsets or earphones adjacent to printed information (explanatory information, legends, labels, etc.) to provide prerecorded playback of the printed materials.

## Braille

Braille is a system of touch reading that employs embossed dots evenly arranged in cells. In each cell, it is possible to place six dots, three high and two wide. Not all people who are blind or have low vision read braille, but those who do will benefit from receiving print materials in this format. Studies over the past three decades agree that 80,000 to 85,000, or eight percent, of people who are blind in the United States use braille for reading.

An experienced person using a braille writer, a mechanical device similar to a typewriter, can produce single copies of braille. A more efficient method is to use a computer with specialized braille software and a printer called an embosser. With training, someone who has minimal knowledge of braille can format and translate simple text documents into

braille using this system. If purchasing the software and printer are beyond an organization's financial resources, contact state or local organizations for people who are blind or have low vision for recommendations on local resources to produce braille materials. Always have braille material and signs checked by an experienced braille reader.

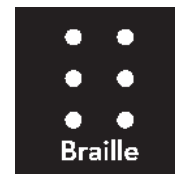

The six dots of the braille cell are arranged and numbered:

1	●	4
2	●	5
3	●	6

a	b	c	d	e	f	g	h	i	j
⠁	⠃	⠉	⠙	⠑	⠋	⠗	⠓	⠎	⠊
k	l	m	n	o	p	q	r	s	t
⠅	⠇	⠍	⠏	⠕	⠕	⠑	⠗	⠎	⠊
u	v	w	x	y	z	Capital Sign	Number Sign	Period	Comma
⠥	⠦	⠪	⠠	⠽	⠞	⠠	⠠	⠠	⠠

The capital sign place before a letter or word capitalizes it.  
 The number sign place before letters a through j makes numbers 1 through 0.

### Braille Alphabet

## Computers, Web Sites and E-mail

Computer technologies are essential tools of communication in our daily lives. The Internet, e-mail and Web sites are used for information, points of sales, educational tools, and are an integral part of the workplace. The arts and humanities must be committed to making sure that these tools are accessible. If an organization uses the Internet or its Web site, for example, to provide information or sell tickets, it cannot exclude people with disabilities.

There are many ways in which technology has been adapted for people who are blind or have low vision as well as people with limited mobility. Most commonly, screen reading software “reads aloud” the text information displayed on the screen—a word processing document, a Web page, an e-mail message. A touch screen on a computer-enhanced display with a lot of text might have an option for “sound off” or “sound on” so that an individual could opt to hear what others see and read on the screen. Web sites can be designed with built-in accessible features.

### Large Print

#### Large Print

Many people who are legally blind or have low vision can read large print. Large print documents are easy to produce using a scaleable, non-italic, sans serif font (such as Helvetica or Arial) in 14 to 18 point size with a space and a half between lines. For effective exhibit labels and displays, print should be a minimum of 24 points or larger, depending upon the distance from which people must read the print.

This is 12 point Helvetica type.

This is 14 point Helvetica type.

This is 16 point Helvetica type.

This is 18 point Helvetica type.

**This is 24 point Helvetica type.**

*Helvetica Type Font Sizes*

**“It is not, in my view just straight-forward access to objects that is important but the whole experience. There is no substitute for exploring the size, shape and smell say of a steam locomotive, the layout of a castle or the shape, the size and intricacy of a carved wooden panel, the sounds of a creaking wooden floor or handling a nautilus shell.”**

Ken Howarth, Heritage Recording, United Kingdom



A 70 percent minimum contrast (black on white is 100 percent), between the print and the paper is critical for best results. Avoid using bright or glossy white paper because it produces glare, or the enlargement option on a photocopier, which usually yields inconsistent and distorted font sizes and blurry copies.

## Readers

If braille or recorded materials are not available, designate someone to read information aloud to people who are blind or have low vision. This is usually effective for short meetings, such as a panel meeting or review session, if the material to be read is not lengthy.

## Tactile Materials

Tactile materials, raised line drawings and diagrams, models and maps, such as scale models of buildings, exhibit layouts or stage settings provide orienting information to someone who is blind or has low vision. Organizations can use models to reproduce objects, artifacts and exhibit pieces that are too large, too delicate, too old or too valuable to handle.

Consider the following when creating tactile maps, models and reproductions:

- Size
- Shape
- Scale
- Original textures
- Detail
- Orientation

Another matter to consider when producing touchable materials is to select items that convey the complex theme of the exhibit or environment. For instance, if the exhibit is about quilts, but a doll happens to be in the exhibit, providing touchable quilts, rather than replicating the doll, might be more appropriate. The key is to avoid random object availability. Involve the curator in selecting tactile items that are significant.

**“If touching weren’t such a good thing, they wouldn’t have to put up all the signs that say ‘Don’t touch.’”**

Ray Bloomer, Director of Education & Technical Assistance,  
National Center on Accessibility

Try to incorporate tactile experiences as a part of the general environment or exhibition. Signage and placement of items indicate what may or may not be touched. Many visitors will benefit from tactile experiences—those who are blind or have low vision, have different learning styles and learn from touching and handling things.



### **Touch Tours**

Touch tours may be developed to enhance the experience of visitors and patrons who are blind or have low vision. Plan the tour so that the visitor has the opportunity to experience things that represent the central themes of the exhibit or environment. Train docents and tour guides to give clear and concise descriptions along with providing tactile and other sensory experiences.

### **For People with Hearing or Speech Disabilities**

People who are deaf or hard-of-hearing have a range of hearing loss. Some people are congenitally deaf while others lose their hearing later in life. The diversity of this community is reflected in the variety of ways available to make audible information accessible.

Many communication access improvements are inexpensive and easy to implement. Useful communication tools may be as simple as providing paper and pencil for writing brief messages. Include a specific person for whom the organization will be providing communication aids, such as an employee or a conference attendee, in determining the type of auxiliary aid that will provide the most effective communication.

### **Assistive Listening Systems**

Assistive listening systems (ALS), in most cases, must be provided for assembly areas where audible communication is integral to the use of the space (concert and lecture halls, live theaters, movie theaters,

**”Advances in technology have ... contributed to the arts by making communications, documentation and production tasks easier to perform. Computer software including computer-aided design, three-dimensional modeling, graphic design, authoring software (in all disciplines), programmed learning, distance learning, the Internet, voice-recognition and voice synthesis systems, as well as other forms of computer and telecommunications technology have provided incredible new opportunities for people with all types of disabilities to be creative and to communicate more effectively.”**

Ron Mace, architect, FAIA

meeting rooms). Accessibility standards require permanently installed systems if (1) an assembly area accommodates at least 50 persons or has an audio-amplification system, and (2) has fixed seating. Other assembly areas may permanently install an ALS or provide a portable system. The minimum number of receivers available must be equal to four percent of the total number of seats, but not less than two receivers. Signage must tell patrons that a listening system is available. (ADAAG 4.1.3)

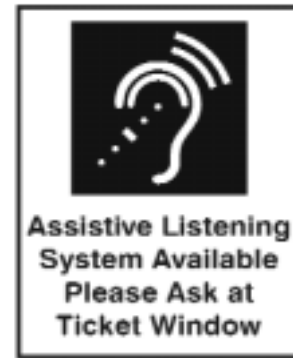

Sign for ALS

An assistive listening system (ALS) minimizes background noise, reduces the effect of distance and overrides poor acoustics. There are three basic types of ALS technologies: audio loop, FM systems and infrared systems.

- Audio loop systems work by transmitting an electromagnetic field to a receiver or directly to an individual's hearing aid. These are often used in small classrooms, lecture halls or conference rooms. The audio loop is usually a permanently installed system.
- FM systems work by transmitting radio waves to receivers. They are commonly used in classrooms, movie and live theaters, large arenas and convention halls. FM systems can be portable or permanently installed.
- Infrared systems work by transmitting sound via light waves to receivers worn by users. They are commonly used in courtrooms, movie and live theaters, convention halls and lecture halls. Infrared systems can be portable but tend to be permanently installed.

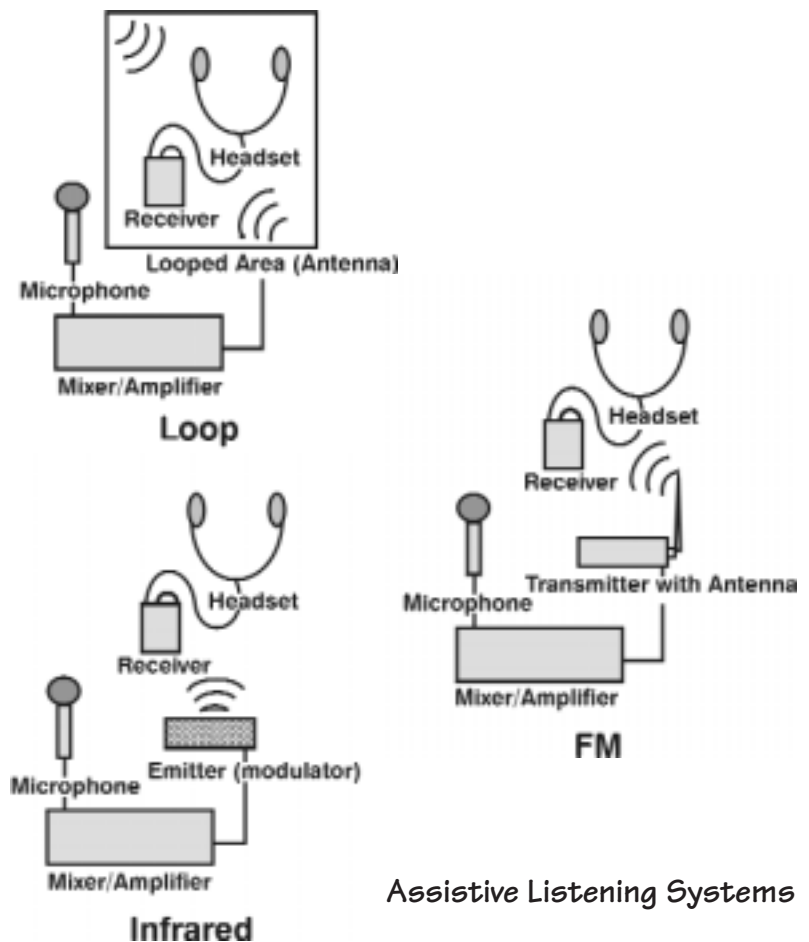

Assistive Listening Systems

The receivers worn by the user must have an output jack to accommodate attachments such as monaural or binaural earpieces, induction neck loops and cochlear implant adapters. The type of attachment required by individuals depends on the severity of their hearing loss and whether they want to use

the receiver with or without their hearing aid. Provide an assortment of attachments so that patrons may choose the options that best suit them.

The same equipment used for an assistive listening system may be used to provide audio description for people who are blind or have low vision. Multi-channel versions of these systems can also be used to deliver simultaneous translations from one language into multiple languages, or one channel could be used for an ALS and another channel used for audio description.

## Captioning

Captioning is the visual display of spoken material. Captioning should also identify who is speaking and indicate non-verbal cues such as sound effects, laughter and music. Individuals who are deaf or hard-of-hearing, who do not know sign language and cannot use assistive listening systems will benefit from captioning.



**Open Captioning** is always visible, preferred by most people and much more user-friendly. With open captioning there are no buttons to push and it is less likely to be subject to technical difficulties and mechanical breakdown. Open captioning also benefits children learning to read, people learning English as a second language, as well as the general public in a noisy environment.



**Closed Captioning** allows the display of captions to be either on or off. Closed captioning is frequently used for television broadcasts, videotapes and DVDs. Cultural organizations often use closed captioning for video presentations with a sign next to the video display stating, “Press the button to view this video with captioning.”



CART Set-Up

## Computer-Aided Realtime Reporting (CART)

Captioning for live performances, lectures, presentations and meetings is sometimes called CART or Computer-Aided Realtime Reporting. Technology changes rapidly, but current CART uses technology developed for the courtroom. Realtime reporters type in a shorthand that specialized computer software instantly translates into full English words and sentences. Then a video monitor, projection screen or LED sign displays the text almost simultaneously. In a small meeting where the system is used by only one individual all that is needed is a laptop computer or two laptops linked together so that what is being typed on one shows up on the screen of the other.

## Sign Language

People who are deaf or hard-of-hearing use a variety of communication methods. Many people who are deaf or who lose their hearing use American Sign Language (ASL) and are very proud of the deaf culture that accompanies the use of ASL. American Sign Language is a complete language, with its own grammatical structure and syntax.

Other communication methods include Cued Speech, Manually Coded English, Pidgin Sign English (PSE) and Signed Exact English (SEE). Someone who knows and understands ASL may not understand SEE or Cued Speech and vice versa. Other deaf or hard-of-hearing individuals may use speechreading (commonly known as lipreading). To ensure effective communication, consult the person who is deaf or hard-of-hearing on their preferred method.

## Interpreters

People who are deaf or hard-of-hearing may request interpreting services to ensure full participation in events, meetings and conversations. Interpreters will interpret between spoken English and American Sign Language (ASL), Manually Coded English, or Cued Speech.

Several interpreters may be needed for long programs. The average time a person can comfortably interpret is about 45 minutes. Most interpreters in lecture, workshop and meeting situations work in teams of two and trade places every 20 minutes. In a theatrical or performance setting, two or more interpreters typically work at the same time to convey a sense of dialogue between characters.



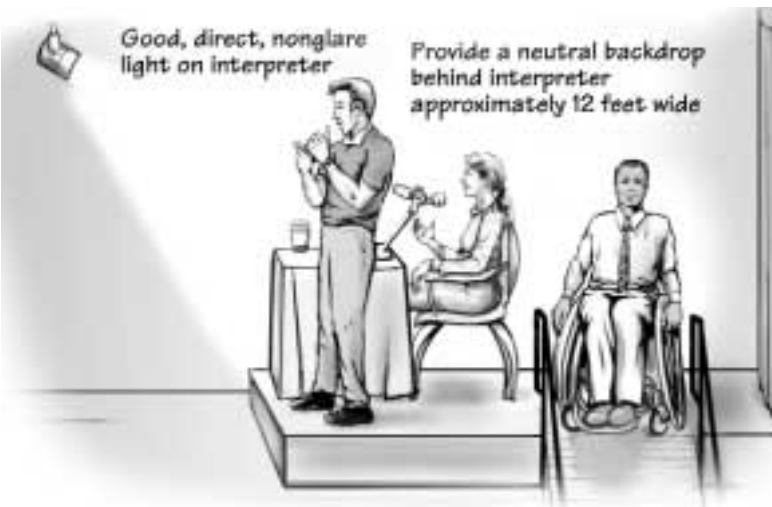

Interpreter Positions

A common location for an interpreter in a classroom, meeting or lecture is at the end of the speakers' table or beside the speaker. In a theatrical setting the best placement of interpreters will vary depending on the performance and the size and shape of the theater. Illuminate the interpreter with light focused on the interpreter's face and upper body and angled to reduce the amount of shadowing on the interpreter's face.

To assure the availability of a qualified interpreter, request the service as soon as the meeting or event is scheduled. Interpreter fees vary from region to region. Interpreters usually charge by the hour with a two-hour minimum; sometimes they will negotiate a flat fee, especially for theatrical or performance interpreting.

A word of caution: someone who knows sign language, but is not a certified or qualified interpreter may not adequately translate the message or provide effective communication.

### Speechreading and Oral Interpreters

Speechreading (often called lipreading) is the ability to perceive speech by watching the movements of a speaker's mouth; observing all other visible clues including facial expressions and gestures; and using the context of the message and the situation. According to the National Association of the Deaf, on the average, even the best speechreaders only understand 25 percent of what is said. Do not assume that someone can speechread.

To effectively speechread, however, individuals must have an unobstructed, well lit view of the speaker's face. Speechreading is most effective one-on-one. It is not effective in group situations, at large meetings or where the speechreader is seated or standing far away from the person speaking. People who speechread may ask to be seated close to the speaker or the stage to improve their ability to understand what is being presented. Some speechreaders use oral interpreters who use clear articulation, facial

expressions and natural gestures to silently mouth the speaker's words, conveying both the message and the emotion.

## TTYs

TTYs are text-based telephones used by people with hearing or speech disabilities to communicate with other TTY users. The first text telephones were teletypewriters, hence the nickname "TTY."

Today's TTYs are small, lightweight electronic devices with a keyboard, a visual display and/or a printer connected to a telephone line.

Equip ticket offices with a TTY so that patrons who are deaf or hard-of-hearing may call to order tickets or get information. Advertise the TTY number along with other ticket office numbers.

If there are public phones available, these should not only be wheelchair accessible, but there should also be provisions made for the public to have access to a TTY. There are specific requirements in the Americans with Disabilities Act Accessibility Guidelines (ADAAG) for the number of public TTYs required and phones requiring amplifiers or individualized volume controls when there are public pay phones available (ADAAG 4.1.3).

## Telecommunication Relay Services

Telecommunication Relay Services allow a person using a TTY to communicate with someone who uses a voice telephone by calling through a relay operator. A trained operator speaks the words typed by a TTY user and types the words spoken by a voice telephone user.

Because of the low cost of a TTY and the efficiency and desirability of one-to-one communication, cultural organizations that conduct a high volume of business by phone or who have staff or volunteers who are deaf, should consider making themselves directly accessible through TTYs rather than relying on relay services. After October 1, 2001, dialing 711 anywhere in the United States will connect the caller to a relay operator who will place a voice or TTY call for the caller.



TTY and TTY Hooked Up



## Telephone Amplifiers

Many telephones come equipped with a volume control switch or amplifier. When requested, local telephone companies can install amplification devices on pay phones. Portable amplifiers for individual use are also available.

### For People with Cognitive Disabilities

The most important service is to provide clear information. People with cognitive disabilities especially appreciate the use of graphic symbols, color and other supplements to clarify the meaning of verbal information. For example, illustrations next to written instructions are easier to comprehend by someone who does not read well and also can be useful to foreign language speakers. Train all staff and volunteers to provide information clearly and to have patience with people who might not understand the first way it is presented.

### Environment

Some people who have developmental or cognitive disabilities may be extremely sensitive to the environment around them. Environments that are too noisy or have too much activity may cause the individual to lose focus or become distracted. Creating areas or zones that are quieter and have fewer visual distractions may enhance some visitors' ability to appreciate an exhibit, presentation or activity.

### Flexibility and Language

Adapting to the needs of the individual visitor or patron is important. If someone has difficulty understanding or appears distracted, try a different way of presenting the information. These tips may help:

- Focus on one topic.
- Keep remarks short.
- Show or demonstrate instead of giving detailed verbal or written descriptions, directions and information.
- Rephrase, simplify or break down concepts into smaller components if necessary.
- Make associations with already familiar ideas and objects.
- Provide objects that people can touch and that appeal to as many senses as possible.
- Use pictures and other visual aids.
- Inform people before transitions to a new location or program.
- Respond to interest or lack of it.



**Pictures**

Pictures can often supplement or substitute for written material. Many ideas can be explained more clearly if accompanied by illustrations. Signs for restrooms, telephones and first aid should use standardized pictographs or symbols.

## RESOURCES

### ASSISTIVE LISTENING DEVICES

#### **Hearing Loss of Association of America (HLAA)**

National Office  
7910 Woodmont Avenue, Suite 1200  
Bethesda, MD 20814  
(301) 657-2248 voice  
(301) 657-2249 TTY  
(301) 913-9413 fax  
[www.hearingloss.org](http://www.hearingloss.org)

#### **Technical Assistance Bulletins for Consumers, Installers and Providers**

United States Access Board  
1331 F Street NW, Suite 1000  
Washington, D.C. 20004-1111  
(800) 872-2253 voice  
(800) 993-2822 TTY  
(202) 272-0081 fax  
[info@access-board.gov](mailto:info@access-board.gov)  
[www.access-board.gov/adaag/about/bulletins/als-b.htm](http://www.access-board.gov/adaag/about/bulletins/als-b.htm)

#### **“Assistive Listening Devices for People with Hearing Loss: A Guide for Performing Arts Settings”**

The John F. Kennedy Center for the Performing Arts  
2700 F Street NW  
Washington, D.C. 20566-0001  
(202) 416-8727 voice  
(202) 416-8728 TTY  
[access@kennedy-center.org](mailto:access@kennedy-center.org)  
[www.kennedy-center.org/accessibility](http://www.kennedy-center.org/accessibility)

**COMPUTER-AIDED REALTIME REPORTING (CART) and SIGN INTERPRETERS****National Court Reporters Association**

8224 Old Courthouse Road

Vienna, VA 22182-3808

(800) 272-6272 voice

(703) 556-6289 TTY

(703) 556-6291 fax

msic@ncrahq.org

www.ncraonline.org

**Association of Late-Deafened Adults (ALDA)**

8038 Macintosh Lane Suite 2

Rockford, IL 61107

(815) 332-1515 voice

info@alda.org

www.alda.org

**Registry of Interpreters for the Deaf**

333 Commerce Street

Alexandria, VA 22314

(703) 838-0030 voice

(703) 838-0459 TTY

(703) 838-0454 fax

www.rid.org

**BRAILLE AND LARGE PRINT****National Library Service for the Blind and Physically Handicapped (NLS)**

Library of Congress

1291 Taylor Street NW

Washington, D.C. 20011

(888) 657-7323 voice

(202) 707-0744 TTY

(202) 707-0712 fax

nls@loc.gov

www.loc.gov/nls

**“Making Text Legible: Designing for People with Partial Sight”  
“Effective Color Contrast: Designing for People with Partial Sight  
and Color Deficiencies”**

Lighthouse International, Arlene R. Gordon Research Institute  
111 East 59th Street  
New York, NY 10022-1202  
(800) 829-0500 voice  
(212) 821-9713 TTY  
(212) 821-9707 fax  
[www.lighthouse.org](http://www.lighthouse.org)

## **PREPARING TACTILE MATERIALS**

### **Tactile Graphics Resources**

Texas School for the Blind and Visually Impaired  
1100 West 45th Street  
Austin, TX 78756  
(800) 872-5273 voice  
(512) 206-9451 TTY  
(512) 206-9450 fax  
<http://www.tsbvi.edu/math/107-graphics/3189-tactile-graphics-resources>

### **RNIB National Centre for Tactile Diagrams**

RNIB Centre for Accessible Information  
58-72 John Bright Street  
Birmingham, B1 1BN, UK  
44 121 665 4257 voice  
44 121 665 4201 fax  
[info@nctd.org.uk](mailto:info@nctd.org.uk)  
[www.nctd.org.uk](http://www.nctd.org.uk)

## **WEB ACCESSIBILITY**

### **The World Wide Web Consortium (W3C) Web Accessibility Initiative**

W3C has established guidelines for accessible web sites.  
World Wide Web Consortium  
Massachusetts Institute of Technology  
32 Vassar Street Room 32-G515  
Cambridge, MA 02139  
(617) 253-2613 voice  
(617) 258-5999 fax  
[www.w3.org](http://www.w3.org)

**Association of Assistive Technology Act Programs (ATAP)**

Provides all kinds of technology related information.

P.O. Box 668

Slingerlands, NY 12159

(202) 643-2827 voice/TTY

[www.ataporg.org/atap/index.php](http://www.ataporg.org/atap/index.php)

**Website Tips.com**

This site is run by an individual, but contains some very good links to resources.

<http://websitetips.com/accessibility>



photo by the Arizona Republic

Heard Museum, Phoenix, AZ: Sculpture by Michael Naranjo, visitor Charlotte Davis

# Accessibility in Arts and Humanities Activities

Humanities and arts organizations face new challenges and opportunities in accessibility as we use the Internet, move outside traditional spaces and experiment with representing our culture. In surveying a cultural program, concern focuses on its location and content. This chapter addresses many situations and issues that are common to the arts and humanities.

Administrators of arts and humanities programs must address three common issues:

### **1. Ensure that all programs, activities and events are accessible to everyone, not just the audience and visitors.**

Traditionally, the focus of accessibility has been on the audience, patron or visitor when, in fact, people with disabilities are also involved with the organization as staff, board and panel members, designers, volunteers, applicants, performers, writers, teachers, technicians, docents, artists and administrators. Do not limit accessibility issues and efforts to the front-of-house or to public areas.

### **2. Carefully evaluate each facility and activity for accessibility in cooperation with knowledgeable individuals with disabilities.**

Routinely survey and evaluate all facilities and activities to ensure accessibility. Consult access advisory committee members: people who use wheelchairs (manual and electric), scooters, crutches or walkers; someone who is blind or has low vision; someone who is deaf or hard-of-hearing; and someone who has a developmental disability, a learning disability or other cognitive disability. Each individual has a unique perspective and helps to ensure a comprehensive view of the facilities and programs.

### **3. Make certain that knowledgeable individuals with disabilities help with designing and reviewing all policies, procedures and practices.**

Clearly thought-out policies and procedures go hand-in-hand with well constructed accessible programs, effective communication and physical access. Plainly stated policies and procedures help staff members and volunteers carry out an organization's plan.

For example: an organization has installed an assistive listening system in the auditorium, a space normally used to show a video documentary and occasionally used for a small lecture series. The new policy will state, "Whenever there is programming of any kind in the auditorium, the assistive listening system will be turned on and be available for use."

The new procedures will include activating the system whenever the video is shown, making sure the system is set up and running during lectures or other events, having the assistive listening receivers properly maintained (clean earpieces, fresh batteries) and handing out the receivers from the information booth just outside the auditorium, starting a half hour before each event.



## Museums, Exhibitions and Visual Arts

### Display Cases

People of short stature or who use various mobility aids (scooters, wheelchairs, canes and walkers) as well as people who have low vision must be able to approach and comfortably view the contents and labels of display cases whether they are wall-mounted or free-standing. An accessible route should allow visitors to get close to the display and provide clear floor space (minimum of 30 inches wide by 48 inches long) beside each display.



Display Case Short



Display Case Tall



Display Case Wall Mount



Tactile Display

The top of free-standing display cases with pedestal bases or legs should be 33 to 40 inches above the floor. If, however, one must look into the case to see an object such as an open book or the inside of a bowl, the top of the display case must be no more than 36 inches above the floor. A display case on legs must have a cane-detectable barrier no higher than 27 inches above the floor.

### Labels

Pay careful attention to making labels legible. Take into consideration placement (distance from the reader), type size, fonts and contrast. Type size varies depending on the distance from which the label will be read. Fonts should be sans serif, such as Arial or Helvetica, with easily recognizable characters. Contrast between the typeface and its background should be strong. Although black on white provides the highest possible contrast, avoid “bright whites” that produce glare.

Consider alternative methods to deliver label information to people who do not read traditional print. Guides and docents may read label information as they give tours, or random-access digital playback devices can provide audio access to label text or other printed information that accompanies exhibits.

### Comfortable Viewing Zone

Both standing and seated people are comfortable viewing large print from 19 inches away when it is between 48 and 67 inches above the floor. Centering signs and labels at 54 inches above the floor works well.

Sighted people can generally read 5/8 inch letters with good contrast at a distance of more than six feet. Sighted people can read smaller type sizes customarily used in exhibition displays at a distance of four feet if the material is printed in maximum contrast.

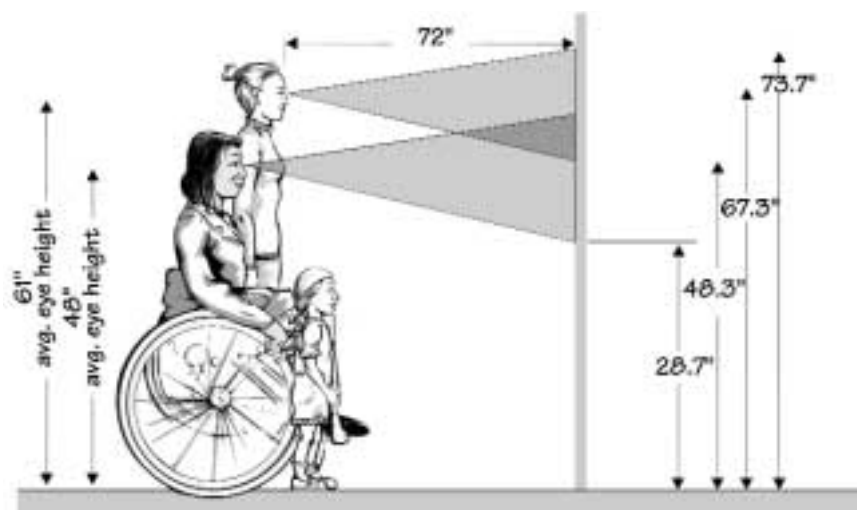

Comfortable Viewing Zone

**Lighting**

For many individuals, poor lighting can make an exhibit completely inaccessible. Be sure that lighting is adequate and avoid abrupt changes in lighting levels and colors. Place lighting instruments carefully so that reflections and glare do not obscure objects whether the visitor is standing, seated or of short stature. Keep shadows off artwork, labels, display cases, objects and pathways. Provide photographs, illustrations or copies of items that are too fragile to be exposed to strong lighting.

**Alternate Formats and Exhibit Content**

Make catalogues, brochures, programs and other print materials available to people who do not use traditional print. A variety of alternate formats exist, such as audiocassette tapes, the Internet, computer disks, large print or braille.

Make any visual content audible and vice versa. Videos should have both captioning and audio description. Written versions of audio tours should be available. Make content and educational programming accessible to people with different kinds of learning styles.

**Tactile Components**

Include tactile components in exhibits. Contemporary but real artifacts (for example, pieces of hand-woven cloth) or reproductions and models add immensely to all visitors' comprehension and understanding. Build small scale models of large objects such as dinosaurs, ships' hulls or tombs. Make these tactile items available to everyone by building them into an exhibit, or include them in a kit that museum staff members or docents use for general visitor education.

Work with curators to make reasonable decisions about which objects may be touched and how. Think about participatory exhibitions as a regular feature of a museum or exhibit. Appeal to people's senses—through touch, hearing, sight and smell. These multi-sensory experiences can enhance the experience for everyone.

**Equipment and Controls**

Controls and switches should not require pinching, grasping or fine motor control to operate. Follow the closed-fist standard—a person with a closed fist should be able to use the object or control. To test the standard, try turning a round doorknob, pushing a lever, typing on a keyboard, switching on a light, grasping a handle or operating a touch-screen with fists closed.

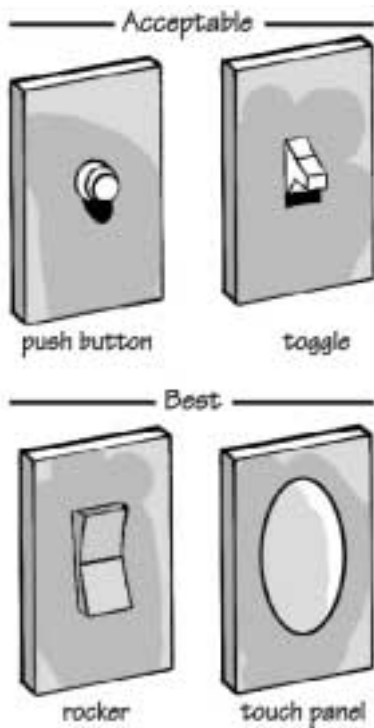

Controls and Switches

Examine interactive exhibits and activities to ensure that individuals with a range of abilities can operate all controls. The controls must be within reach of a person who is short or seated. Operable parts should be placed between 15 inches and 48 inches from the floor. Controls or switches should be easy to reach and easy to find. If necessary, relocate the control or add a second switch.

Controls and interactive exhibits that give feedback should be both audible and visual. For example, if identifying the right answer on a quiz causes a bell to ring, also include a visual cue such as a blinking light.

### Tours

In general, the areas, items and information included in tours should be available to everyone. Docents and tour guides should receive ongoing training on how to interact appropriately and how to offer assistance to people with disabilities or older visitors. Invite people with disabilities from the community and/or advisory committee to talk to docents and tour guides about basic disability etiquette, how to communicate, and “what to do” and “what not to do” in order to make everyone feel more comfortable.

### Tour Route

The tour route should meet all the requirements for an accessible route or pathway. A person who uses a wheelchair should be able to get in and out of buildings, rooms, and sections, and move along the tour route without encountering steps, curbs, turnstiles, narrow doors, rough or uneven surfaces or other barriers. Include seating with armrests for people who walk with difficulty or tire easily. Design a flexible route so those who cannot complete the whole tour can easily return to the start or rest while others complete a segment of the route.

The tour route must be well lit and free from hazards such as objects that protrude into the path of travel (display cases hung from walls), things that hang low overhead (tree branches or wall sconces), items that might trip people (wires or uneven changes in surface level) or other barriers that might be particularly dangerous.

### Docents

Train docents and tour guides to orient people who are blind or have low vision to the spaces they will encounter along the tour by describing the size or dimensions of rooms, spaces and hallways. Clear concise descriptions

of objects that highlight shape, size, texture and colors are also useful. A docent or guide can deliver a more formal audio description tour by memorizing or reading from a script. Visitors who are blind or have low vision may take self-guided tours by using an audio description tour on audiocassette or a random access digital playback system.

Teach docents and tour guides to feel comfortable working with sign language interpreters. Remember to walk, stop and then talk. Face the individuals who are deaf or hard-of-hearing to facilitate speechreading. Give participants time to look at objects after the interpreter has finished interpreting the oral presentation. Portable assistive listening systems can also help people who are hard-of-hearing enjoy a tour. As a last resort, providing a printed copy of the tour script may help.

Flexibility is an essential skill for a docent or tour guide. Applying the concepts mentioned above, not overloading people with more information than they can handle, and adapting content to the learning level of the participants makes a tour better for everyone. Guides should be flexible and patient, and avoid talking down to or patronizing visitors. Remember that showing and experiencing is frequently better than lecturing.

## **Performing Arts and Lectures**

### **Ticket Office**

The ticket office is a place where communication is particularly important and where patrons frequently get their first impression of the organization. The ability to purchase tickets and obtain information must be available to everyone, whether face-to-face with ticket office staff at the window, over the phone, using a TTY or through the organization's Web site.

### **Ticket Prices and Policies**

Free or reduced admission fees for people with disabilities are not required. There are several good reasons, however, to consider a discounted admission policy. One reason is to bring a new audience into the facility by giving people the opportunity to try a new experience with minimum financial risk. Further, people on fixed incomes, including retirees, appreciate discounted tickets.

Another reason is to compensate for lack of equal access or limited choice. For example, if the organization is located in a historic structure and cannot create integrated and dispersed seating and the only accessible seating is located in the most expensive area, or if choice is limited (accessible seating is clustered in the first or last row), the organization should have a policy of selling the accessible seating at the least expensive ticket price.

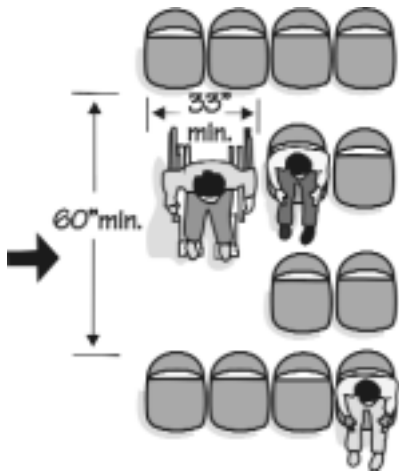

Aisle Space for One

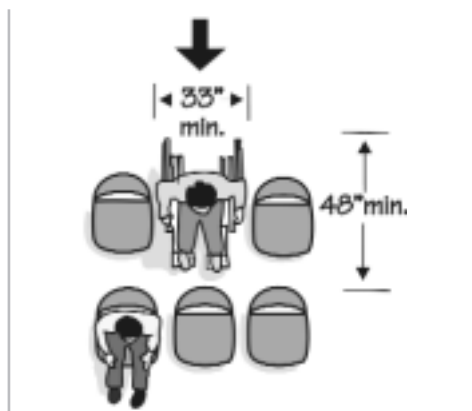

Back-Row Space for One

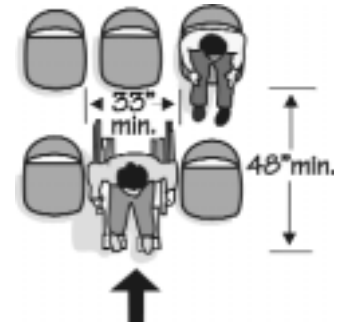

Front Row Space for One

front row wheelchair position  
omit two chairs, 33" x 48" clear floor space

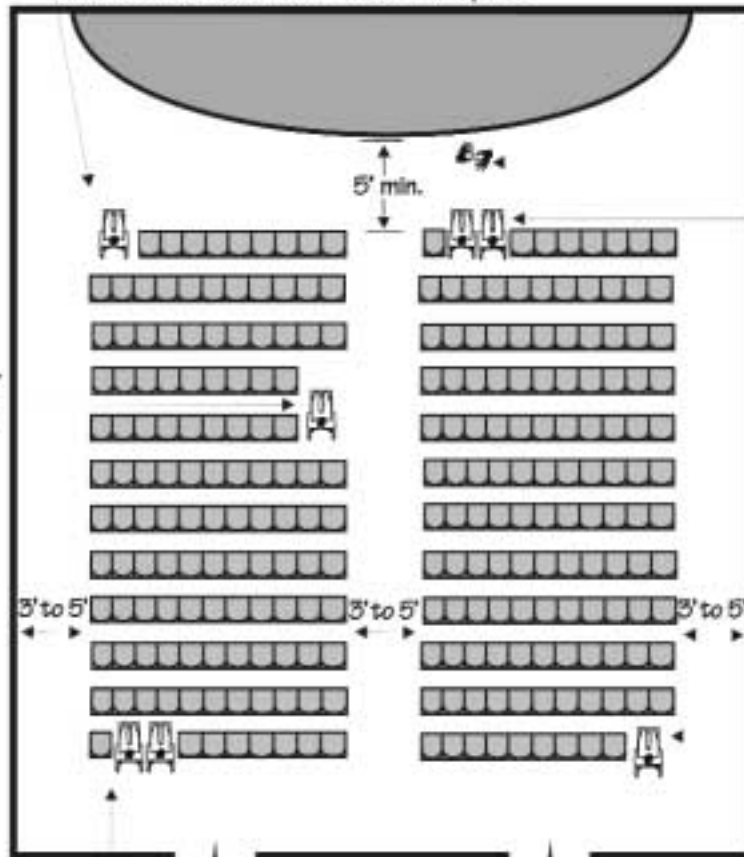

midpoint wheelchair  
position, 33" x 60"  
clear floor space

Interpreter  
66" x 48" clear  
floor space

back row  
wheelchair position  
omit two chairs  
33" x 48" clear  
floor space

back row position for two  
wheelchairs - omit three chairs  
66" x 48" clear floorspace

doors 5lbf max. opening force

Integrated and  
Dispersed Seating  
Locations

## Seating Locations

Wheelchair-accessible seating spaces must be integrated and dispersed—available near the front, the back, the middle, sides and center, in the orchestra, in balconies and in boxes. Design seating to allow people using wheelchairs, scooters or other mobility aids to sit with their friends and family. If wheelchair users choose to transfer to theater seats, their wheelchairs should remain next to them so that they may move about, as needed, like everyone else.

Listed below are general guidelines from ADAAG on wheelchair accessible seating. Remember, these are minimum requirements; organizations can always provide more and better accessible seating:

- **Size:** Each wheelchair location must be a minimum of 33 inches wide and 48 inches deep for forward or rear access and 33 inches wide by 60 inches deep for side access. The space must be level (not sloped), provide maneuvering clearances (room to pull in and out) and allow the individual to face the stage without sitting sideways or twisting. Sightlines must be unobstructed.
- **Placement:** Wheelchair locations must be integrated and dispersed throughout the auditorium seating area with a seat for a companion next to each wheelchair accessible location.
- **Removable armrests:** One percent of the seats must have removable or folding armrests.
- **Number:** The minimum number of wheelchair locations required is based on overall seating capacity of the venue.

The following are the two sets of minimum guidelines for accessible seating. It is recommended that organizations aim to use the highest possible standard or, better yet, exceed the standard.

## Americans with Disabilities Act Accessibility Guidelines (ADAAG) for Seating Requirements

Seating Capacity in Assembly Area	Minimum Number of Required Wheelchair Locations
4 to 25	1
26 to 50	2
51 to 300	4
301 to 500	6
over 500	six plus one additional space for each total seating capacity increase of 100

### Uniform Federal Accessibility Standards (UFAS) for Seating Requirements

Capacity of Seating & Assembly Areas	Minimum Number of Required Wheelchair Locations
50 to 75	3
76 to 100	4
101 to 150	5
151 to 200	6
201 to 300	7
301 to 400	8
401 to 500	9
501 to 1,000	*
Over 1,000	**

\*2 percent of total.

\*\*20 plus 1 for each 100 over 1,000.

Some people who are deaf or hard-of-hearing may request seats near the front so they can easily see interpreters, captioning or use speechreading. However, with infrared and FM assistive listening systems, individuals who are hard-of-hearing can usually sit anywhere in the theater.

People who are blind or have low vision also may want seats near the front where visibility is best or seats near the center where the sound is best. Listen carefully to requests made by patrons to determine what will best suit their needs. Guide dogs and other service animals stay with their owners at all times.



Guide Dog in Theater

### Guide Dogs and Other Service Animals

The ADA and laws in every state permit guide dogs and service animals anywhere the general public is allowed, including taxis and buses, restaurants, theaters, stores, hotels, apartment and office buildings. These animals enhance independence for people with disabilities by reducing reliance on other people. Service animals are trained to perform tasks such as guiding someone around obstacles, pulling a wheelchair, alerting when the phone or doorbell rings, retrieving dropped objects and opening doors.

### Alternate Formats

Print materials, such as playbills or program books, must be available in alternate formats such as large print, braille or audiocassette recording. Staff members and volunteers need



to know what is available, where these items are kept and how to provide them. Signage should inform patrons about the availability of print materials in alternate formats.

### **Assistive Listening Systems and Audio Description**

**Audio description:** Audio description is usually delivered live, with the possible exception of pre-show, prerecorded “program notes,” for people who are blind or have low vision.

**Assistive listening systems:** Most theaters, concert halls and lecture halls must have equipment to enhance sound for people who are hard-of-hearing.

The most common systems used for these two accommodations are FM and infrared. Be sure to carefully maintain the equipment. Keep it clean (receivers, earphones) and batteries charged or replaced regularly.

Staff or volunteers who distribute the equipment must be trained to understand how it works and be able to explain it to patrons. Be sure that staff understands the different functions of the equipment since the same or almost identical equipment is used for both assistive listening and audio description. The equipment should be easy to find and convenient to obtain. Post signs using the appropriate icons to announce the availability of these services.

### **Captioning**

During performances, captioning or CART (computer aided realtime reporting), which benefits older adults and those who do not know sign language, can be displayed on a video monitor, projection screen or LED sign displays. Live performance venues usually use the LED sign because it releases the least amount of light into the theater. Hire a qualified captioner, provide proper placement of the captioning equipment and the display device and supply appropriate seating for those using the captions.

Some theaters have experimented with a system that uses a standard laptop computer, an ordinary word processing program and specialized software that displays the pre-entered text of a script on an LED. During the performance a person uses the laptop to move the script forward in time with the actors’ delivery of the lines. Opera surtitle systems can also be used to deliver captioning. WGBH in Boston has developed a system called the Rear Window® Captioning System used by some movie and IMAX theaters.

### **Sign Language Interpretation**

Determine where to place interpreters for performances and lectures as far in advance as possible. In determining the best position, include the interpreters and a patron or knowledgeable person who is deaf. The style of interpreting

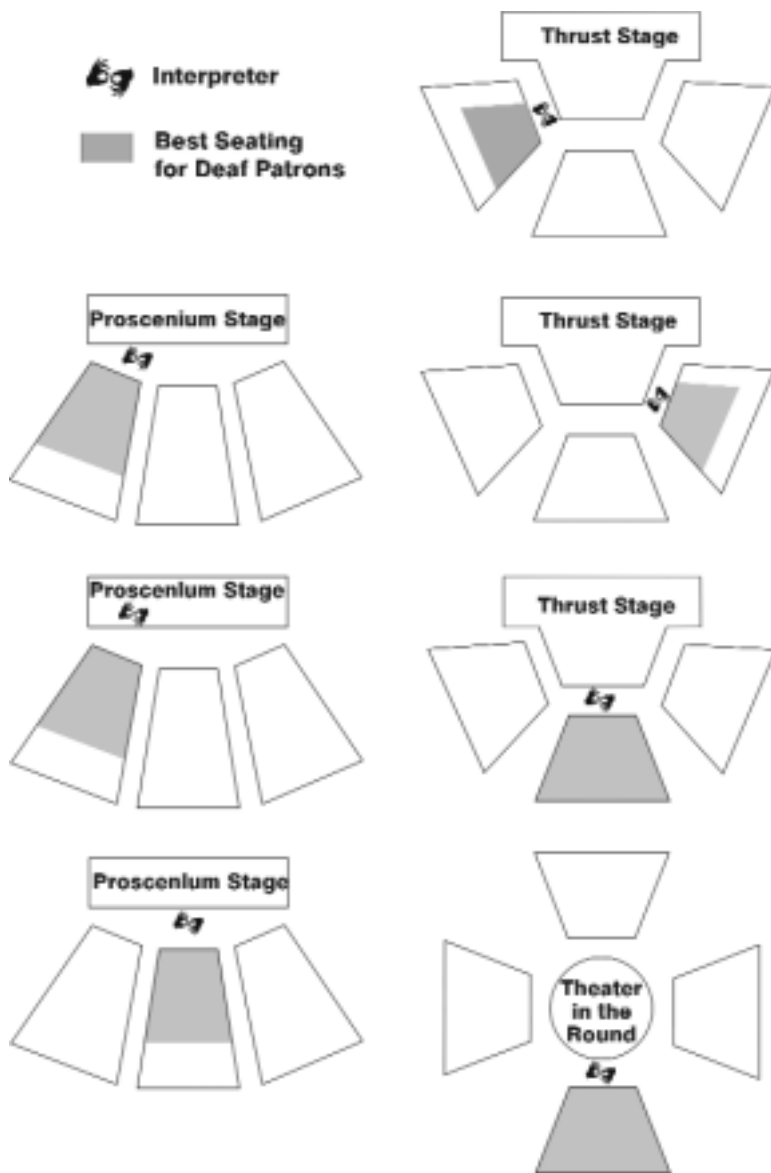

Interpreter Position in Theaters

selected must provide effective communication for the audience and mesh with the artistic concept of the production.

Place the interpreters to the side or front of the action in the field of vision of audience members. Depending upon the configuration of the theater and the scenery, the interpreters may be standing or sitting together on stage, at the side of the stage or just below the stage in the audience portion of the theater. Carefully consider these issues:

- Audience members must be able to clearly and comfortably see the interpreter and the stage simultaneously.
- Light on the interpreters should be neither too dim nor too bright and not cast shadows on the interpreters' faces or torsos.
- Select qualified, and preferably certified, interpreters who are familiar with theatrical material. Not all interpreters may be qualified or comfortable with musicals or Shakespeare.
- Carefully prepare contracts for interpreters that outline how much they will be paid, what they will be expected to do (prepare for the performance, arrive on time, dress professionally) and what the organization will provide (copies of scripts, tickets to preview the performance, complimentary tickets.)

**“Because the motion picture and television industry has a powerful impact on the shaping of public opinion, many feel it also has a responsibility to portray persons with disabilities accurately and sensitively. The media has an unchallenged ability to break down invisible barriers, altering those attitudes that can be the most formidable obstacles to a person with a disability’s profitable interactions with and contributions to society.”**

Karen G. Littman, President, Morphonix, San Rafael, CA

### **Touch Tours**

Touch tours before a performance are another option for providing visual information about stage sets, costumes, performance areas and props. Signage should announce the availability of touch tours.

### **Contractual Language for Accessibility**

Contracts should clearly outline who will be responsible for accessibility. For example, a performing arts company on tour should be just as accessible to audience, performers and staff as when at the home facility. Because the responsibility for compliance falls equally on the performing arts troupe and on the facilities in which it performs, clearly spell out who will be responsible for ensuring physical and programmatic access and who will be responsible for providing effective communication.

### **Multimedia: Film, Video, Radio, Television, Web sites and the Internet**

Media arts programs involve many different activities in the production, distribution, exhibition or broadcast of films, videos, television, radio, Internet media and other mixed media or multimedia. In addition, media arts may involve workshops, conferences, seminars, distance education programs, lectures, residencies or working space for independent artists, as well as the production of research and newsletters.

### **Representation**

The media arts are a particularly powerful tool for influencing how society sees itself. Through exhibition and broadcast, a media producer conveys ideas and values that would not otherwise reach a wide circulation.

Including people with disabilities in productions can change attitudes. Persistent casting, writing and presentation of people with disabilities and older adults in everyday roles focusing not on disability or age, but on the person, can expand their public image. In addition, seeing professionals with

**“Why do you always have to use our condition as reason for inspiration? I don’t always want to be inspiring. I just want to be me and accepted like everyone else. Whether I am liked or disliked should be based on who I am as a person, not who I am as a physical entity. I want people to loathe my character sometimes. I want to play murderers, kidnappers or whatever. If you are going to show us as equals, then you’ll have to make room for all those situations. I would like to play roles that are written regardless of disability. That’s my ultimate goal, to eliminate the necessity to even mention disability.”**

Alan Toy, actor

disabilities working in all aspects of the arts and humanities increases public awareness of people with disabilities in realistic terms, as capable members of society who pursue interesting and creative employment.

### **Location**

When going on location, filmmakers and producers of television, radio and video programs must consider what accommodations will need to be made so that people with disabilities or who are older can participate. Include the actors, production crew and others in determining what accommodations they may need.

### **Products**

Television, film, video and the Internet are pervasive elements in our culture. Building accessibility into media products allows everyone to enjoy them. Be sure to incorporate captioning and audio or video description during the production of such products.

Captioning for film, video and television is most effective when technical concerns are taken into account at the earliest planning stage. During production, attention must be given to contrast, letter size, presentation rate and line length. When producing audio-visual materials, be sure to budget for captioning, and hire professionals or acquire the newest captioning software.

The National Endowment for the Arts requires of its grant applicants that “broadcast projects and educational/interpretive videos must be closed or open captioned.” The National Endowment for the Humanities requires that “television and film projects produced under an NEH grant must have closed captioning. Costs for this should be included in the production budget.”

### **Computer Technology and the Internet**

New technologies enable people with disabilities to be more independent and productive in the workplace. People who are blind or have low vision can benefit from screen reading software and computerized speech synthesizers. A person with limited motor movement can benefit from modified keyboards, trackballs and ultrasonic pointers or voice recognition. People who are deaf or hard-of-hearing can use visual icons in place of sounds and captioning for audio content.

**“The power of the Web is in its universality. Access by everyone regardless of disability is an essential aspect.”**

Tim Berners-Lee, W3C Director and inventor of the World Wide Web

Taking advantage of the newest technologies and adaptive technologies allows cultural organizations to make Web sites as well as programs and events more accessible.

Section 508 of the 1973 Rehabilitation Act applies to all federal agencies when they develop, procure, maintain or use electronic or information technology. Federal agencies must ensure that this technology is accessible to employees and members of the public with disabilities to the extent that it does not pose an “undue burden.” Under standards published by the Access Board on December 21, 2000, the federal government will be in the forefront in ensuring access to electronic and information technology. These standards, the first of their kind in the federal sector, cover various means of disseminating information, including computers software and electronic office equipment. They provide criteria that spell out what makes these products accessible to people with disabilities, including those with vision, hearing and mobility loss.

### **Guidelines to Help Ensure Web Accessibility For Everyone**

- Start with understandably written, clearly presented information.
- Make meaning independent of color and employ color, fonts and graphics judiciously.
- Employ a consistent layout and include a site map.
- Label forms and frames clearly.

Use these evaluation tools and others like them to analyze Web page accessibility:

- [www.webable.com](http://www.webable.com)
- Bobby at [www.cast.org/bobby](http://www.cast.org/bobby)
- LIFT at [www.usablenet.com](http://www.usablenet.com)
- InSight and InFocus at [www.ssbtechnologies.com](http://www.ssbtechnologies.com)

### **Assuring that Web sites are available to:**

People who are Blind or have Low Vision

- Supply descriptive text attributes (i.e., HTML tags “alt” and “longdesc”) for images, links, graphs, charts, tables and maps.
- Convert PDF files to text (some screen readers can’t read PDF files).
- Provide audio to describe videos.

People who are Deaf or Hard-of-hearing

- Offer text or visual cues for all auditory information (voice, sounds, etc.).
- Caption videos.

People who have Motor Impairments

- Design easy site navigation (menu bar on each page, limit the number of clicks needed to navigate through the site, etc.).
- Allow keyboard commands for those who cannot use a mouse.



*Artist with Disability*

## Literary Activities

Literary activities include creating, publishing, promoting, distributing and presenting literature. In addition, activities may involve graphic arts productions, printing, readings, workshops, exhibits and book fairs, as well as writing, translation and editing. These activities may take place in a variety of locations, ranging from printing shops to classrooms to shopping malls.

Considering accessibility becomes necessary when the work of literary art becomes public, is produced in a place of public accommodation, or is part of an educational program or conference. A poetry reading in a cafe, a book fair in a church social hall, a workshop at a community college, a presentation by an author at a bookstore or an exhibition in a local library must be accessible because these are all places of public accommodation.

## RESOURCES

### ACCESSIBILITY CHECKLISTS

#### **“Arts Accessibility Checklist”**

National Endowment for the Arts  
Office for AccessAbility  
1100 Pennsylvania Avenue NW  
Washington, D.C. 20506  
(202) 682-5532 voice  
(202) 682-5496 TTY  
(202) 682-5715 fax  
[www.nea.gov/resources/Accessibility/Planning/Step6.pdf](http://www.nea.gov/resources/Accessibility/Planning/Step6.pdf)

#### **“Museum Accessibility Checklist for Visitors who are Deaf or Hard of Hearing”**

Please contact the Center to request a copy of this resource.  
Center for Hearing and Communication  
50 Broadway, 6th Floor  
New York, NY 10004  
(917) 305-7700 voice  
(917) 305-7999 TTY  
(917) 305-7888 fax  
[www.chchearing.org](http://www.chchearing.org)

### LABELING AND EXHIBIT DESIGN

#### **“Everyone’s Welcome: The Americans with Disabilities Act and Museums”**

#### **“Standards Manual for Signs and Labels”**

American Association of Museums  
1575 Eye Street NW, Suite 400  
Washington, D.C. 20005  
(202) 289-1818 voice  
(202) 289-6578 fax  
(202) 289-9127 bookstore  
[www.aam-us.org](http://www.aam-us.org)

#### **“Smithsonian Guidelines for Accessible Exhibition Design”**

Smithsonian Accessibility Program  
Arts and Industries Building  
Room 1239 MRC 426  
Washington, DC 20560  
(202) 786-2942 voice  
(202) 786-2414 TTY  
(202) 786-2210 fax  
[http://www.ofeo.si.edu/ae\\_center/accessibility.asp](http://www.ofeo.si.edu/ae_center/accessibility.asp)

## **TOURS FOR VISITORS WHO ARE BLIND OR HAVE LOW VISION**

### **“Reaching Out: A Creative Guide for Designing Cultural Programs and Exhibits for Persons who are Blind or Visually Impaired”**

by Elga Joffe and Mary Ann Siller  
American Foundation for the Blind  
2 Penn Plaza, Suite 1102  
New York, NY 10121  
(800) 232-5463 voice  
<http://www.afb.org/store>

## **ACCESSIBLE MEDIA (CAPTIONING AND AUDIO DESCRIPTION)**

### **Audio Description Project**

Initiative of the American Council of the Blind (Formerly AD International).  
This site lists Audio Description providers nationally and internationally.  
[www.acb.org/adp/](http://www.acb.org/adp/)

### **Described and Captioned Media Program**

This site has numerous resources for both captioning and audio description.  
National Association of the Deaf  
1447 East Main Street  
Spartanburg, SC 29307  
(800) 237-6213 voice  
(800) 237-6819 TTY  
(800) 538-5636 fax  
[info@dcmp.org](mailto:info@dcmp.org)  
[www.dcmp.org](http://www.dcmp.org)

### **Media Access Group at WGBH**

The Caption Center and Descriptive Video Service®  
This organization has numerous resources for both captioning and audio description.  
Media Access Group WGBH  
One Guest Street  
Boston, MA 02135  
(617) 300-3600 voice/TTY  
(617) 300-1020 fax  
[access@wgbh.org](mailto:access@wgbh.org)  
<http://main.wgbh.org/wgbh/pages/mag/>



**National Captioning Institute**

This organization has numerous resources for both captioning and audio description.

3725 Concorde Parkway, Suite 100 Chantilly, VA 20151

(703) 917-7600 voice/TTY

(703) 917-9853 fax

mail@ncicap.org

www.ncicap.org/

**“Technical Bulletin #8: Theatrical Movie Captioning Systems”**

Access Board

1331 F Street NW, Suite 1000

Washington, D.C. 20004-1111

(800) 872-2253 voice

(800) 993-2822 TTY

(202) 272-0081 fax

info@access-board.gov

www.access-board.gov/adaag/about/bulletins/captioning.htm

**Accessible Media****National Center for Accessible Media (NCAM)**

The Corporation for Public Broadcasting/WGBH National Center for Accessible Media (NCAM) is a research and development facility that works to make media accessible.

The CPB/WGBH National Center for Accessible Media

WGBH Educational Foundation

125 Western Avenue

Boston, MA 02134

(617) 300-3400 voice/TTY

(617) 300-1035 fax

NCAM@wgbh.org

http://main.wgbh.org/ncam

**Electronic and Information Technology****The Federal Information Technology Accessibility Initiative (FITAI)**

Coordinated by U.S. General Services Administration (GSA), this interagency effort offers technical assistance to individuals and federal agencies on implementation of Section 508.

www.section508.gov

### **The Access Board**

An independent federal agency that has numerous technical assistance bulletins that address the Telecommunications Act and Section 508 including:

“Bulletin#7: Access to Telecommunications”

“Section 504 Facts – Brochure”

To download these documents and many more go to:

<http://www.access-board.gov/pubs.htm>

## **Working with Actors with Disabilities**

### **“Everything You Always Wanted To Know About Working With Performers With Disabilities But Were Afraid To Ask”**

Screen Actors Guild (SAG)

(212) 827-1433 (New York)

(323) 549-6643 (Los Angeles)

[www.sag.com](http://www.sag.com)

American Federation of Television & Radio Artists (AFTRA)

(212) 532-0800 (New York)

(323) 634-8100 (Los Angeles)

[www.aftra.org](http://www.aftra.org)

Actors Equity Association (AEA)

(212) 869-8530 (New York)

(323) 634-1750 (Los Angeles)

[www.actorsequity.org](http://www.actorsequity.org)





photo by Al Fuchs

Cleveland Dancing Wheels, Cleveland, OH: "The Sorcerer's Apprentices" with dancers Jennifer Sikora and Sabatino Verlessa

# Meetings, Panels, Lectures and Conferences

Many arts and humanities organizations conduct meetings, lectures, conferences and panels. Making these accessible to people with disabilities must be a priority. Any meetings that are open to the public must comply with the provisions of Section 504 of the Rehabilitation Act and the Americans with Disabilities Act. Public meetings must be held in physically accessible spaces and provide effective communication for people with disabilities and who are older.

The following information is adapted with permission from the ERIC/OSEP Special Project, the ERIC Clearinghouse on Disabilities and Gifted Education, the Council for Exceptional Children. Download the complete information brief at: [www/ericec.org/digests/e735.html](http://www/ericec.org/digests/e735.html)

## **Choosing an Accessible Site**

Always make a site visit before committing the organization to a facility. The goal of the site visit is to select a conference setting that allows persons with a disability or older patrons to move about the conference site freely and independently and to participate in the program. Working with a local independent living center or other access group to assist in evaluating the accessibility of the site is highly recommended. The site visit should include inspecting the space and amenities to be used during the conference, meeting or lecture. Consider whether the distance and route between buildings, meeting rooms and amenities will be easy to traverse. Verify the accessibility of any outside entertainment or transportation services that will be used. Make certain the staff of the hotel or conference center are trained to handle issues of accessibility. Consider the following points in selecting a site:

- Is accessible parking and public transportation available?
- Are exterior pathways and main entrances accessible? This means a participant will not encounter stairs, any sudden change of floor height over 1/4 inch, slippery or unstable ground, doorways less than 32 inches wide and objects obstructing walkways.

- Are directions to meeting rooms and amenities clearly posted at entrances? Assigning staff to entrances to provide directions and assistance to meeting participants is also useful.
- Are interior pathways accessible? Take a look at the width of halls, corridors and aisles. Check for level, stable surfaces.
- Are restrooms, public telephones (including a TTY), water fountains and sleeping rooms (if needed) accessible?
- Is there adequate space for wheelchairs in meeting rooms, as well as at conference and banquet tables?
- Are tables and chairs set up to allow integrated and dispersed spaces for people using wheelchairs?
- Is the lighting adjustable and are all areas well lit?
- Is the environment obstacle-free? This means free of protruding objects, objects in the middle of pathways and trip hazards?
- Are there large print, tactile directions for equipment, elevators and restrooms? Check to see that elevator control panels have braille with raised characters.
- Are the emergency egress routes accessible and are there visual/audible alarms?
- Are registration and display tables no higher than 36 inches? Clipboards can be made available as an alternate writing surface for persons of short stature or with limited mobility.
- Is there a tactile/visual map of conference area?

### Accessible Transportation

Don't forget about transportation for participants with disabilities. If the organization is providing transportation for participants, it must be prepared also to provide wheelchair accessible transportation. Likewise, if an organization is sponsoring a festival and is operating courtesy shuttle buses from remote parking locations, it must provide accessible shuttles or make other arrangements to accommodate people who have limited mobility, including those who use wheelchairs.

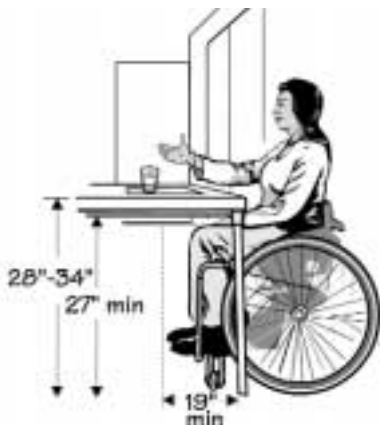

Table Clearance

### Promotion and Registration

Conference planners should arrange for all promotional material to be available in alternative formats, such as braille, large print, computer disk, e-mail or through the Internet. Designate someone on staff to handle all issues concerning accommodations for participants during the meeting.

In all conference material, including the registration form and press release, indicate that accommodations can be made for a variety of needs. Here are some examples:

- “If you have a disability and may require accommodation to fully participate in this activity, please check here. Someone from our staff will contact you to discuss your specific needs.”
- “Accommodations for individuals with disabilities will be provided with at least three weeks advance notice. Please check here or notify (conference planner) to request an accommodation at (phone) and (e-mail).”
- “Check here if you require: (insert a checklist of accommodations such as sign language interpreters, wheelchair accessible seating.)”

### Social Functions and Meals

When planning social functions and meals, meeting planners should:

- Include personal assistants and interpreters in the estimated number of participants.
- Make adequate provisions for seating, allowing all participants to sit in the same area. Do not place people using wheelchairs, or those who use walkers or guide dogs, on the fringes of the dining area.
- Avoid buffet lines. They can be particularly difficult for persons with mobility or vision loss. If buffet lines can't be avoided then, request the catering service provide additional staff to assist attendees.
- Ensure that buffet/refreshment tables are no higher than 36 inches or have staff available to assist upon request.

### Accessible Presentations

The meeting planner should work with invited speakers and presenters to ensure that presentations are accessible to all people. Attention to the following points will enhance the accessibility of conference presentations.



### Registration Planning Information

If you need any of the following accommodations, please indicate below and submit this form no later than (date i.e., 3 weeks before event) so that staff will have sufficient time to fulfill your request. Include your phone number and/or e-mail so that we may contact you if more details are needed.

- Wheelchair Accessible Hotel Room
- Assistive Listening System
- Wheelchair Accessible Transportation
- Oral Interpretation
- Sign Interpretation
- Print Material Recorded on Cassette
- Large Print Materials
- Dietary Restrictions (specify)

Other:

### Example of access section of registration form

### In General

- Select well lit and easily accessible meeting rooms.
- Control background noise.
- Choose a meeting room with good acoustics and an auxiliary sound system.
- Arrange for multiple types of microphones: table, lapel and floor microphones with horizontal booms or an assistant with a hand-held microphone. Remember that presenters, interpreters and audience members use microphones.
- Establish unobstructed pathways to microphones for audience members' questions and statements.
- Discuss with each presenter, prior to the meeting, the importance of developing a presentation that will be accessible to all participants.
- Find out if a presenter requires an accommodation such as a ramp, accessible podium, chair, interpreter or sighted guide. It is more desirable to seat presenters at a table, but if a podium is being used, it must have a detachable microphone for those who cannot or choose not to use the podium.
- Instruct presenters to speak in well-paced and well-modulated tones. It is particularly important for presenters to monitor their rate of speech and not speak too rapidly.



Floor Mike with Boom

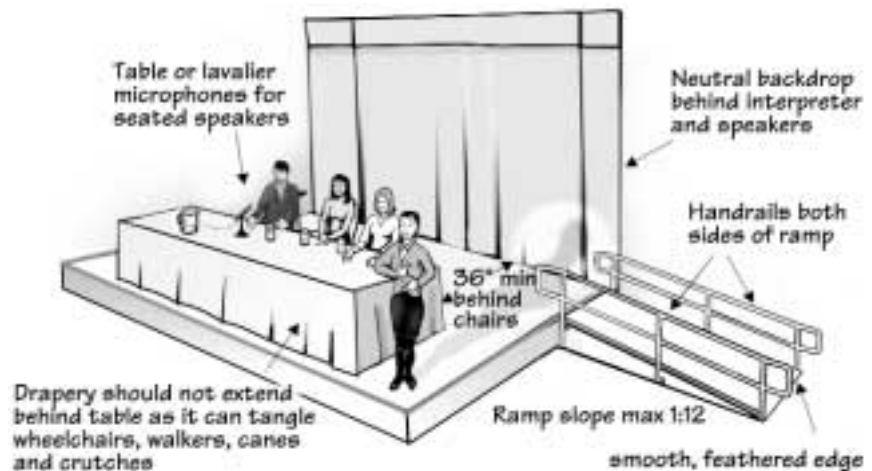

Speakers Platform

### For People Who Are Blind or Have Some Vision Loss

Note that the items listed here may also increase accessibility for sighted individuals with reading or learning disabilities.

- Orient participants to the site and layout of the spaces, identify the location of amenities and exits. Provide transparent, raised-line maps of conference area including braille or raised letters with corresponding print layouts underneath. The raised-line, tactile maps should identify meeting rooms, food services, restrooms, exits and other amenities.



- Allow access to front row seats during meeting sessions.
- Have a staff member or volunteer available to sit with participants and describe the presentations, if desired.
- Offer papers, agendas or other print materials in alternative formats such as large print or braille.
- Make available for close examination large print copies of transparencies, PowerPoint presentations or slides.
- Check for adjustable lighting in the meeting room. Dimming the ceiling lights can increase the contrast—and thus the visibility—of audiovisual materials.
- Use sharply contrasting colors and large print for materials, maps, books, signs, menus, forms and displays.
- Have each person state their name before speaking so that participants who are blind or have low vision can track the course of the conversation during question and answer periods and facilitated group discussions.

#### **For People who are Deaf or Hard-of-Hearing**

- Allow preferred seating for those who wish it, usually in front of the speaker and interpreter. Preferred seating should be away from heating and air conditioning units, hallways and other noisy areas.
- Keep lights bright in the area where the presenter and interpreter stand. Keep lights on the interpreters during PowerPoint, video or other visual presentations.
- Check that window coverings are adjustable to reduce or remove glare.
- Arrange seats in a circle for small discussion groups.
- Provide captioning, CART (Computer Aided Realtime Translation) or qualified, professional interpreters.
- Set up an assistive listening system and check that it functions properly before the presentation starts.

Several site visits may be necessary prior to an event. Keep in mind that with continued communication and education, organizations will achieve the goal of accessible, barrier-free conferences and meetings for all individuals.

## RESOURCES

### PLANNING ACCESSIBLE MEETINGS

#### **Independent Living Centers**

To find the Independent living center closest to you, contact:  
[www.ilusa.com/links/ilcenters.htm](http://www.ilusa.com/links/ilcenters.htm)

#### **“Planning Accessible Conferences and Meetings: An ERIC/OSEP Information Brief for Conference Planners”**

<http://www.hoagiesgifted.org/eric/e735.html>

#### **“A Guide to Planning Accessible Meetings”**

by June Isaacson Kailes and Darrell Jones  
ILRU (Independent Living Research Utilization) Program  
2323 South Shepherd, Suite 1000  
Houston, TX 77019  
(713) 520-0232 voice/TTY  
(713) 520-5785 fax  
[www.ILRU.org](http://www.ILRU.org)

### ACCESSIBLE LODGING

#### **“Accommodating All Guests”**

The American Hotel & Lodging Association  
1201 New York Avenue NW, Suite 600  
Washington, D.C. 20005-3931  
(202) 289-3100 voice  
(202) 289-3199 fax  
[www.universaldesign.com/information/hospitality.php](http://www.universaldesign.com/information/hospitality.php)

#### **“Common ADA Problems at Newly Constructed Lodging Facilities”**

#### **“Five Steps to Make New Lodging Facilities Comply with the ADA”**

#### **“Americans with Disabilities Act Checklist for New Lodging Facilities”**

Disability Rights Section  
Civil Rights Division  
U.S. Department of Justice  
950 Pennsylvania Avenue NW  
Washington, D.C. 20530  
(800) 514-0301 voice  
(800) 514-0383 TTY  
(202) 307-1197 fax  
[www.ada.gov/publicat.htm](http://www.ada.gov/publicat.htm)

## **PRODUCING BRAILLE MATERIALS AND TACTILE MAPS**

### **Braille Institute of America**

741 North Vermont Street  
Los Angeles, CA 90029  
(800) 272-4553 voice  
(323) 663-0867 fax  
[www.brailleinstitute.org](http://www.brailleinstitute.org)

### **American Printing House for the Blind**

P.O. Box 6085  
Louisville, KY 40206-0085  
(800) 223-1839 voice  
(502) 899-2274 fax  
[info@aph.org](mailto:info@aph.org)  
[www.aph.org](http://www.aph.org)



photo by VSA arts staff.

Arts for All Gallery, Atlanta, GA: Visual artist Marquetta Johnson with her work

# Training for Staff, Board Members, Volunteers and Constituents

A cultural organization's most important accessibility asset is its people—staff, board members, volunteers and constituents (including applicants and grantees). The time and energy invested in training people to understand and accommodate those with disabilities can make the difference between simply fulfilling legal obligations and providing a truly welcoming experience for everyone.

The goal of any training program is to better educate participants on how to be more inclusive—to be comfortable involving individuals with disabilities in their activities.

Always include people with disabilities when developing and delivering training programs (i.e., members of the accessibility advisory committee) because such first-hand learning increases awareness and encourages cooperation. Individuals with disabilities add a valuable perspective, can recount experiences they have had as staff, participants or visitors, and demonstrate effective techniques to increase accessibility. Be sure to leave enough time for questions and discussion.

Trainings should model accessibility. Hold trainings in accessible spaces, provide handouts in large print, have a sample in braille, be sure videos are captioned and/or audio described, and provide sign language interpreters so that people can experience accessibility.

**“I like to begin awareness talks with my ABCs of Art and Accessibility. Full inclusion means providing access for Artists, Administrators and Audience members; this happens by building Bridges, not Barriers, with Co-operation, Communication, and Creativity.”**

Pamela Walker, artist, administrator and audience member

Provide anyone unable to attend training with training materials and keep them abreast of the organization's accessibility efforts. Offer training on a regular basis to accommodate newcomers and to provide a refresher on the basics and information about new services.

## **Components of an Effective Training Program**

The following are eight key components that should be included in every effective training program or workshop.

### **1) The Organization's Commitment to Accessibility and Etiquette**

Discuss the organization's commitment to providing superb service by treating all people with courtesy and attentiveness while complying with the Americans with Disabilities Act, Section 504 of the Rehabilitation Act and applicable state and local laws.

Offer general tips on courteous behavior and good customer service. People with disabilities themselves are the most effective in covering such issues, including:

- See the person, not the disability. Don't "talk down."
- Speak directly to the individual, not to a companion or an interpreter.
- Treat adults as adults. Be considerate. A person with a disability may take extra time to say or do things.
- Relax. Do not worry about using common expressions such as "See you later" or "I've got to run."

**"Maybe it's high time that people with disabilities, the artists of the world, tell it like it is, about how our lives impact all of humanity, how we improve the fabric of society, how we contribute to our economy, how we are a part of our families and our communities."**

John D. Kemp, lawyer and former CEO and President of VSA arts

## 2) Define “People with Disabilities”

Discuss what the word “disability” means and how people don’t always conform to stereotypes. Many disabilities are hidden, invisible and not easily detected. People with disabilities range from the person who has difficulty walking great distances to the person who uses a wheelchair; one who is blind and uses a guide dog to the person who cannot adjust quickly to changes in lighting conditions; someone who has age-related mild hearing loss to the person who is congenitally deaf.

## 3) Needs of Older Adults

While older individuals may not need specific assistance, they can benefit by others understanding their needs. Aspects of the organization and its facility may be frustrating for older people, such as:

- The distance one has to walk from the car or front door to one’s seat.
- Finding one’s way around a large and confusing building.
- Lack of a place to sit with armrests while waiting.
- Poorly lit areas or floor levels that change unexpectedly.



## 4) Language

Talk about the importance of language and its power to include or exclude. People with disabilities want to be viewed with respect and dignity like anyone else. Insist upon language that promotes inclusion. Equip staff and volunteers with appropriate “people first” language information.

Keep in mind that there are regional differences regarding acceptable use of language. Members of the cultural organization’s accessibility advisory committee can advise and talk about politically correct language in the community.

## 5) Communication

Recommend good communication practices such as the following:

- Give the individual your complete attention.
- Always introduce yourself by name and say that you work for the organization and in what capacity (e.g., staff, docent, volunteer, usher or tour guide).

- Always face the individual. Never carry on a conversation while standing behind someone or turn away from someone while speaking.
- Speak clearly and distinctly but do not exaggerate or shout.
- Give clear and concise directions.
- Be flexible with language. If the person does not understand, rephrase the statement using simpler words.



Usher Escorting Patron

## 6) Offering Assistance

Talk about the important responsibility of offering assistance. Never be afraid to ask someone, “May I assist you?” If the offer for assistance is accepted, ask the person, “How may I assist you?” or “What can I do to assist you?” Most people will appreciate the offer, while others may neither need nor want assistance. Nevertheless, the offer to assist is never wrong. Do not insist if help is refused.

If a person states a need, trust their explanation and respond respectfully. An individual’s safety and comfort are always important considerations.

Discuss with staff and volunteers what is appropriate in assisting people with disabilities. The law prescribes some of this and the organization’s policies should dictate the remainder.

For example, a theater might direct its front-of-house staff and volunteer ushers to follow specific guidelines in assisting patrons with disabilities, such as:

**DO** Hold or stabilize wheelchairs while patrons transfer to a conventional seat.

**DO** Push peoples’ wheelchairs to the restroom if requested.

**DO** Assist a patron in purchasing beverages or getting to a water fountain if requested.

**DO** Help people to be comfortable.

**DON’T** Lift or carry people.

**DON’T** Accompany them into the toilet area.

**DON’T** Feed or administer medication.

**DON’T** Do anything to jeopardize your own or patrons’ safety.



## **7) Describe and Demonstrate Services and Auxiliary Aids**

Describe and demonstrate all available accommodations, including services and auxiliary aids. Never assume that staff, volunteers, ushers and docents know what services and accommodations are available or how they work. If the organization uses multiple facilities, be specific as to which accommodations are available (and where) in which facilities. Discuss not only what is provided, but what a patron or visitor with a disability may bring with them, such as different types of equipment and service animals.

## **8) How to Respond to Emergencies**

Staff and volunteers should know the organization's procedures for evacuating the building and handling medical emergencies.

For example, a museum might direct its security staff and docents to follow specific guidelines during emergencies, such as:

- Do not make physical contact with any visitors, even if the intention is to calm them. They may find even solicitous physical contact frightening or disorienting.
- Be considerate of all individuals but do not allow inappropriate behavior.
- In the event of a medical emergency, injury or visible illness, call for trained medical personnel. Unless the situation is life threatening, do not attempt to render first aid and do not move the ill or injured person unless the environment is life threatening.
- Take necessary steps to accommodate medical personnel (i.e., clear theater aisle and turn on house lights so they may safely evacuate the person).
- Know where all accessible emergency exits are located and be prepared to evacuate people from the building calmly and safely.

## **Producing an Accessibility Conference or Workshop**

With regard to arts and humanities service organizations, access issues should become an integral agenda item of your conferences, workshops, seminars and orientations. For example, include someone with a disability to discuss: access issues on an audience development panel, universal design on a facilities panel or audio description in a media presentation. Having cultural administrators who conduct accessible programs present their success stories is highly effective. Presenters should include the planning process, funding, marketing as well as any problems and successes they experienced.

Think about what an accessibility workshop at a conference should include:

- The focus of all access education should be inclusion: integrating older adults and people with disabilities into the cultural mainstream for full and equal participation.
- The workshop/conference itself should be a model of an accessible meeting.
- Although the meeting may be condensed into a one-day workshop, these activities should be presented over a two-day period for best results.

The agenda for a conference or workshop on accessibility should be comprehensive. The following is a sample agenda:

- 1) Opening Remarks (10 minutes) by a key member of your organization (director, chairman, board member).
- 2) Opening Panel (45 minutes) chaired by board member:  
“Access from the Artists’ or Humanities Scholars’ and/or Cultural Administrators’ Perspective”  
At least three panelists with disabilities and older adults who are artists, scholars or administrators of a cultural organization:
  - What the arts or the humanities mean to them.
  - Examples of their personal experiences in gaining access to the humanities or arts (both positive and negative experiences).
  - Their advice to cultural administrators on how to better serve people with their particular needs.
- 3) Panel (45 minutes)  
“The Americans with Disabilities Act and Section 504”
  - A speaker (i.e., lawyer) presents an overview of the laws translated into how they apply to cultural groups, including rented/donated space, touring and other relevant subjects. (15-20 minutes)
  - A cultural administrator discusses his/her organization’s access policies and grievance procedures and (if applicable) experience in resolving a grievance or formal complaint. (10 minutes)
  - Questions and answers. (15 minutes)
- 4) Speakers at Luncheon and Dinner (20 to 30 minutes for each presentation)  
One speaker per meal who may be an artist, humanities scholar, head of a cultural organization or a board member who is actively engaged in access issues; or a performance by professional artist(s) with disabilities.

5) Concurrent panel sessions (1-1/2 hours for each concurrent segment; 2 to 4 panels for each time-slot)

The number, topics covered and frequency of panels will depend on the length of your conference. Each panel should include no more than three speakers and at least one panelist with a disability. Question and discussion time must also be included in each session. Suggested topics are:

- “Making Access a Reality”: discussion of policy, access advisory committee, public affairs and marketing issues.
- “Education and Outreach”: model programs that reach and include people with various disabilities.
- “Access: It’s More than a Ramp”: designing for increased access through the self-evaluation process.
- “Universal Design”: the concept of going beyond minimum standards and making access features an integral part of all design, including programs and facilities.
- “Adapting Existing Facilities and Historic Preservation Issues.”
- “How to Hold an Access Training Workshop.”
- “Technologies that Advance Accessibility” (i.e., audio description, captioning, assistive listening systems).
- “Resources for Change”: funding opportunities (i.e., Community Development Block Grants) and organizations that provide technical assistance on accessibility (i.e., Independent Living Centers, VSA arts).

6) Closing Session “Planning for the Future” (one hour)

In the closing session, participants discuss “where do we go from here,” and “what is needed to do it?” This valuable session will help your organization identify next steps, and ways that you may work together to advance access in your community.

## RESOURCES

### EXAMPLES OF TRAINING TOOLS

#### **“Be Yourself. Say Hello!”**

by Eleanor Rubin and Maureen Albano

Please call or email The Museum of Fine Arts, Boston, to request a copy of this resource.

Museum of Fine Arts, Boston

Avenue of the Arts

465 Huntington Avenue

Boston, MA 02115-5523

(617) 369-3302 voice

(617) 267-9703 TTY

access@mfa.org

www.mfa.org

#### **“Train Your Staff”**

A component of an accessibility guide called “A Step By Step Guide To Accessible Arts In California”

National Arts and Disability Center

University of California Los Angeles, Semel Institute

760 Westwood Plaza, Suite 67-467

Los Angeles, CA 90095-1759

(310) 794-1141 voice

(310) 794-1143 fax

<http://nadc.ucla.edu/10steps.cfm>

#### **“Disability Etiquette Handbook”**

The City of San Antonio Texas Planning Department and the Disability Advisory Committee

[www.sanantonio.gov/ada](http://www.sanantonio.gov/ada)

#### **“Ten Commandments of Etiquette for Communicating with People with Disabilities”**

UCP National (aka United Cerebral Palsy)

1660 L Street, NW, Suite 700

Washington, D.C. 20036

(800) 872-5827 voice

(202) 973-7197 TTY

(202) 776-0414 fax

info@ucp.org

[www.ucp.org/ucp\\_generaldoc.cfm/1/9/6573/6573-6573/190](http://www.ucp.org/ucp_generaldoc.cfm/1/9/6573/6573-6573/190)





photo by Jamie Bosworth

Tygress Heart Shakespeare Company, Portland, OR: "Twelfth Night" with Michael Fisher, Julie Gebron interpreting

# Audience Development And Marketing

For most people, the decision to participate in cultural events is effortless; decide to go, then go. Potential patrons and visitors with disabilities must have that same choice or freedom to choose. This handbook's goal is to guide cultural administrators toward planning for inclusion so that people with disabilities can be full participants wherever they go for arts and cultural activities.

Another barrier to inclusion is attitude. If an organization does not communicate a welcoming environment to its community, the community's perception of the organization will not be positive.

## **Invite, Welcome and Respect**

To develop any new audience, cultural organizations should take four essential steps:

1. Invite
2. Welcome
3. Respect
4. Repeat the process.

**“We consider inclusive environments an opportunity for audience building and better constituency service. The New York State Council on the Arts formed an access advisory committee of staff, council members and people from the field (including artists with disabilities) to help us develop a three-year plan that would enhance the usability of the arts for all New Yorkers. We asked our arts organizations to tell us what they had already done and what they thought they needed to do. We also asked them how we could help. The most frequent request from the field was for information and resources. As a result we added a section on universal planning and accessibility to our Web site; we instituted an e-mail address you can use to receive information on accessibility; we began a regular column on accessibility in FYI; and we convened 17 workshops on accessibility around the state.”**

Nicolette B. Clarke, Executive Director, New York State Council on the Arts

Build relationships outside the office and at the potential patron's or visitor's own premises. From there, develop a network of interested individuals and groups, then bring them into the organization's space and involve them in its activities. Go beyond legal obligations and think about the benefits and advantages of exemplary accessibility.

Ignoring potential audiences does not make good sense. Accessibility allows organizations to tap new audiences and to keep established audiences longer.

Develop trust and win the confidence of potential patrons and visitors who have disabilities so that they will become and continue to be part of the organization's audience. Invest time and energy building the organization's credibility. Commit to becoming a cultural organization that is welcoming and inclusive. Remember that audience development requires persistence, consistency, patience and time.

## **Basic Strategies and Tools for Marketing Accessibility**

- Use the cultural organization's regular advertising and marketing materials to promote accessibility.
- Target specific groups. Identify organizations that provide services or work with people with disabilities and educate these groups about the cultural organization's programs.
- Be sure that communication instruments are fully accessible, including Web site and print materials.
- Include accessibility information in all marketing materials from brochures and posters to television and radio ads to Web sites and e-mail and listservs (e-mail-based mailing lists). Include as much detailed information as possible or at a minimum, always include a basic accessibility statement. For example:



“The Kentucky Center for the Performing Arts welcomes patrons with disabilities.”

- Promote accessible features and programs with detailed, welcoming information. For example:
 

“Krannert Center is nationally known as a leader in accessibility because of our wide range of services. Krannert Center offers wheelchair and easy access seating in all theatres, plus usher assistance in getting from the parking lot to your seats. Infrared hearing amplification systems also are available in all four theatres. We will gladly arrange for a sign-language interpreter for any performance, and the ticket office can be reached by TTY for patrons



who are deaf, hard-of-hearing or speech impaired. For patrons who are visually impaired, we provide large print or braille programs plus audiotaped versions of our calendars and brochures. Three weeks advance notification for accommodations is requested. For more information call our patron services manager at (217) 333-9716 or (217) 333-9714 (TTY).”

- Do not overlook the powerful tool of “word of mouth” advertising. Promote accessibility through the staff and volunteers who have contact with the public—receptionists, docents, tour guides, speakers, information center workers, ticket sellers, house managers, ushers, board members and even other audience members.
- Launch a full-scale effort to inform existing and potential audiences, visitors, patrons and participants. Let them know that the program and facility are accessible and that the organization welcomes the patronage and involvement of people with disabilities.

## **Targeting a Specific Population or Group**

Begin by involving people from the target group in the cultural organization’s efforts. They will provide the accessibility coordinator with advice, recommendations and introductions to members of the local community. Target agencies and organizations that are by and for people with disabilities with information they can share with their constituents. For example, when captioning is provided for a lecture, notify the local Self Help for Hard of Hearing People (SHHH) organization or a similar organization.

- Compile mailing and e-mail lists of local service agencies, organizations by and for people with disabilities, schools, membership groups and social clubs.
- Search the Internet and the phone book for organizations and programs for people with disabilities. Obtain recommendations and referrals from accessibility advisory committee members.
- Use access symbols or pictograms that have meaning to people the organization wishes to attract as shorthand to indicate that accessible accommodations and services are available. Be advised that using these symbols promises accessibility to an organization’s facilities and programs.
- Create an information fact sheet, brochure, booklet or an accessibility map of the entire facility and all programs, accessibility features, services, accommodations, policies, procedures and how to take advantage of the accessibility features.
- Circulate accessibility information to everyone in the organization—include it in new employee packages and distribute to all staff, volunteers, docents, interns, directors, designers, performers and to patrons and visitors.
- Show up, support and be a visible presence in the community. Have the organization’s staff invited to speak at meetings, conferences and events;

set up booths and displays; and distribute literature. Be proactive. Do not just wait for people with disabilities to seek out the organization.

- Learn from the concerns and issues that people bring to the organization's attention. Do not make promises the organization cannot keep. Do not be afraid to say you do not know, but always be ready to find out.

And, finally, do it all again, and again and again. Audience development requires persistence, consistency, patience and time.

## Useful Tools

### Writing and Speaking about People with Disabilities and Older Adults

Always refer to a person first, rather than a disability; this emphasizes a person's worth and abilities. Vocabularies change constantly, but the following five "Never Uses" are here to stay.

- Never use the word "handicapped"; the word is "disability."
- Never use a disability as an adjective. It is not a blind writer, but a writer who is blind. Focus on the person, not the disability.
- Never use "special"; this separates the individual from the group. For example, information is not required regarding the "special needs of the group," but "needs of the group."
- Never use euphemisms, such as "physically challenged" or "handicapable." These are condescending.
- Never use labels: "the disabled," "the blind," "the deaf," "A.B.s" (able-bodied), "T.A.B.s" (temporarily able-bodied) or "normal." Labeling people is never acceptable.

Affirmative	Negative
People with disabilities A disability	The handicapped The impaired The disabled The unfortunate
Person without disabilities Non-disabled person	Able bodied Normal person (This implies a person with a disability is not normal.)
Person who is blind Person who is partially sighted or has low vision	The blind
Person who is deaf Person who is hard-of-hearing	The deaf or deaf mute Suffers a hearing loss (“Suffers” dramatizes a disability.)

**Affirmative**

**Negative**

Person who uses a wheelchair  
Person with limited mobility

Wheelchair bound  
Confined or restricted to a wheelchair  
(People use wheelchairs for mobility and freedom.)

Person who has muscular dystrophy  
Person who has multiple sclerosis  
Person who had polio

Stricken by MD  
Afflicted by MS  
Polio victim  
(“Stricken,” “afflicted,” and “victim,” all imply helplessness, and emotionalize and sensationalize a person’s disability.)

Person with mental retardation

The retarded

Person with learning disabilities

The learning disabled

Older person  
Older adult  
Mature adult

The aged  
The elderly  
Senior citizen











Person of short stature  
Little people

Dwarf or Midget  
Diminutive person

**Disability Access Symbols**

The 12 symbols at right may be used to promote and publicize accessibility of places, programs and other activities for people with various disabilities. These symbols help advertise access services to customers, audiences, staff and other targeted populations.

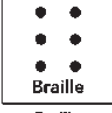
Language accompanying the symbols should focus on the accommodation or service, not on who uses it. For example, “Ramped Entrance” may accompany the wheelchair symbol. This is important because individuals with wheelchairs use ramps, but so do people with baby strollers and luggage. Language that fosters dignity is important, too. For example, “Reserved Parking” or “Accessible Parking” may be used with the wheelchair symbol to indicate parking spaces designated for people with disabilities.

		
Accessibility	Assistive Listening Systems	Closed Captioning
		
Large Print	Sign Language Interpreted	Audio Description
		
Open Captioning	Telephone Typewriter (TTY)	Access (Other Than Print or Braille) for Individuals Who Are Blind or Have Low Vision
		
Braille	Volume Control Telephone	Information

## How to Communicate a Disability-Friendly Message

The following questionnaire should be easy to pass after reading this chapter. The following is adapted and used with permission from The Solutions Marketing Group SMG, 2334 South Rolfe Street, Arlington, VA 22202, [www.disability-marketing.com](http://www.disability-marketing.com).

While people with disabilities may require the use of an auxiliary aid or accommodation for independence, they also purchase the same products and want the same experiences as non-disabled consumers. Statistics indicate that organizations that include people with disabilities in their ads attract more people with disabilities and sell more products. They also get positive feedback from both people with and without disabilities.

**Q.** If an organization includes people with disabilities in general market ads, there's no need to advertise in disability specific publications or Web sites.

True  False

**A.** False: Including people with disabilities in general market advertising is a first step in creating a disability-friendly message. However, an organization solidifies its credibility by making an investment in the disability community. This is accomplished by advertising in publications, Web sites and by sponsoring and attending conferences that are targeted at people with disabilities. Targeted ads must demonstrate that an organization understands the needs of people with disabilities.

**Q.** What must an organization do to effectively serve people with disabilities?

- A. Conduct disability awareness and customer service training sessions for employees.
- B. Wait until a lawsuit has been filed by a person or disability organization.
- C. None of the above.

**A.** Organizations must perfect their internal as well as external operations. Equip employees to serve people with disabilities effectively. Provide training so employees develop familiarity when interacting with people with disabilities.

**Q.** An organization should test market approaches and events, programs and services to people with disabilities.

True  False

**A.** True: When creating new marketing approaches and programs, always include people with different disabilities within the development team. They are most familiar with their needs, uses for a program or service and the possibility for multiple applications by people with different disabilities. An organization that is serious about pursuing people with disabilities should never make marketing or program development decisions without testing the marketing approach and obtaining input to shape the strategy.

## **RESOURCES**

### **TOOLS FOR MARKETING**

#### **The Disability Access Symbols Project**

This site has the access symbols which can be downloaded in different formats.

Graphic Artists Guild Foundation

32 Broadway, Suite 1114

New York, NY 10004

(212) 791-3400 voice

(202) 791-0333 fax

president@gag.org

[www.graphicartistsguild.org/resources/disability-access-symbols/](http://www.graphicartistsguild.org/resources/disability-access-symbols/)

#### **“Guidelines for Writing and Reporting About People with Disabilities”**

RTC/IL Publications

University of Kansas

1000 Sunnyside Avenue #4089

Lawrence, KS 66045-7555

(785) 864-4095 voice

(785) 864-0706 TTY

(785) 864-5063 fax

rtcil@ku.edu

[www.rtcil.org/products](http://www rtcil.org/products)



photo by Stan Barouh

Arena Stage, Washington, DC: "The Miracle Worker" with Shira Grabelsky and Kelly C. McAndrew

# Accessibility is a Work in Progress

Accessibility is and should be a work in progress. Routinely review and evaluate services, accommodations and physical access. With rapid changes in technology as well as the changes within the disability community, what was acceptable and worked fine yesterday may not be the best an organization can do today.

If something isn't working, for example, no one is using the braille self-guided tour scripts to the art gallery, then evaluate and determine why. Does the content have broad appeal to the audience that the organization is trying to reach? In this example, there may not be a large audience of people who read braille and who are interested in abstract two-dimensional visual art. The organization may want to shift resources to touch tours of outdoor sculptures or provide the self-guided script in large print. Work with advocacy groups or an accessibility advisory committee to establish and re-establish priorities.

How large or small is the community in the organization's region? For example, the area may have a very small population of individuals who are deaf and use sign language, but a large population of people who are hard-of-hearing. Is the organization offering an accommodation that doesn't suit or meet the needs of people with disabilities in its area? Don't be afraid to customize services or provide various options to suit the audience, community and region. What works in Cleveland doesn't always work in St. Louis.

There may be some simple explanation for why an accommodation isn't successful. For example, an organization decides to offer a discount ticket program on Thursday evenings to draw in older adults. The organization tried this for a while, but it didn't seem to have the desired results. If they had gotten input from an advisory committee the organization would have learned that transportation wasn't available on Thursday evenings in their area and many older people as well as other individuals with vision loss may not drive at night.

Keep an eye on changing technologies. Twenty years ago only a few companies provided FM assistive listening systems; now there are numerous

resources for this equipment. The equipment has also improved. Some examples of ways in which technology has changed include:

- Infrared assistive listening systems originally had only one channel for transmission and now there are multi-channel systems.
- For years the only way to open a door was to grab it and pull. Now there are electronic door openers that are activated by pushing a button or walking in front of an electronic sensor.
- Not too many years ago the idea that a computer could talk, read aloud, or respond to its user's voice was completely alien—not so today. Many new technologies can be used to improve or enhance accessibility.

Most important, remember to check with people in the community to find out about changing attitudes. When the 1973 Rehabilitation Act, Section 504, was first implemented, people who used wheelchairs rarely objected to entering through a side or back entrance. Simply getting inside was the goal. Now, more than a decade after the Americans with Disabilities Act was passed, just “getting in” is no longer acceptable. People want to enter by the same door as everyone else; second-class citizenship is no longer acceptable. These changes in attitude mean that cultural organizations must be ready to make changes in accessibility, policies and procedures to meet the current expectations of the community.

### **The Core Principles of Accessibility**

- Access to cultural programs is a federal law and a legal requirement of Section 504 of the Rehabilitation Act and the Americans with Disabilities Act.
- Access is an organizational asset and must be integrated into all facets and activities, from day-to-day operations to long-range goals and objectives.
- Access accommodations and services must be given a high priority and earmarked in the budget process.
- Access has economic benefits because people with disabilities and older adults are a significant part of the population and they constitute a large potential market for the arts and the humanities.
- Access is a social issue. People with disabilities are included in the definition of “diversity.” Promoting diversity and inclusion ensures broader access to the arts for all people.
- Access is a civil right. Assuring equal opportunity for everyone is a fundamental starting point for all accessibility efforts.

**“An experience that’s rich and meaningful for participants who have disabilities will almost certainly be rich and meaningful for others, but the reverse isn’t necessarily true.”**

John Slatin, Institute for Technology and Learning, University of Texas at Austin, Austin, TX



# Design for Accessibility: A Cultural Administrator's Handbook



National Assembly of  
State Arts Agencies  
KNOWLEDGE \* REPRESENTATION \* COMMUNITY



MetLife Foundation

## Credits

This book was produced in 2003 through an interagency agreement between the National Endowment for the Arts (NEA) and the National Endowment for the Humanities (NEH) and through an NEA cooperative agreement with the National Assembly of State Arts Agencies and contract with The John F. Kennedy Center for the Performing Arts.

### National Endowment for the Arts

Dana Gioia, Chairman  
Hope O'Keefe, General Counsel  
Paula Terry, Director, Office for AccessAbility  
Suzanne Richard, Accessibility Specialist,  
Office for AccessAbility

### National Endowment for the Humanities

Bruce Cole, Chairman  
Lauren Walsh, Assistant General Counsel  
Heather Gottry, Assistant General Counsel  
Nancy E. Weiss, Former Deputy General Counsel

### National Assembly of State Arts Agencies

Jonathan Katz, Chief Executive Officer  
Dennis Dewey, Managing Director  
Johanna Misey Boyer, Director of Leadership Development

### The John F. Kennedy Center for the Performing Arts

Michael Kaiser, President  
Derek E. Gordon, Senior Vice President  
Betty Siegel, Manager of Accessibility

### Project Manager

Betty Siegel, The John F. Kennedy Center for the Performing Arts

### Project Editor/Writer

William V. Patterson, University of Maryland,  
College Park, MD

### Editor

Katharine Bird, American Association of Retired People,  
Washington, DC  
Andi Mathis, National Endowment for the Arts,  
Washington, DC

## Writers

Charles Goldman, Esq., Washington, DC  
Ann-Ellen Lesser, AL Projects, Spencertown, NY  
Mary Lincer, Freelance Arts Writer-Educator,  
Washington, DC  
Sharon Parks, National Park Service, Historic Preservation  
Division, Washington, DC  
John P. S. Salmen, AIA, Universal Designers &  
Consultants, Inc. Takoma Park, MD

## Illustrations

Adaptive Environments, Boston, MA  
Adaptive Environments, Boston, Massachusetts  
Kathy Gips, Project Manager  
Gabriela Sims, Illustrator  
The Creative Group, Boston, Massachusetts  
Peter Kimmins, Illustrator  
James McDermott, Illustrator

## Designer

Simmons Design, Alexandria, VA

## Researcher

Celia M. Hughes, VSA arts Texas, Austin, TX  
Jennifer Nord, The John F. Kennedy Center for the  
Performing Arts

## Reviewers

Robert Booker, Minnesota State Arts Board,  
Saint Paul, MN  
Cindy Brown, Artability, Phoenix, AZ  
Gail Burke, Minnesota State Arts Board, Saint Paul, MN  
Kathy Gips, Adaptive Environments, Boston, MA  
Jan Majewski, Smithsonian Institution, Washington DC  
David Park, National Park Service, Washington, DC  
Randall Rosenbaum, Rhode Island State Council on the  
Arts, Providence, RI  
Brenda Tharp, Texas Commission of the Arts, Austin, TX  
Oliver Tuholske, National Endowment for the Humanities,  
Washington, DC  
Charles J. Washburn, VSA arts of Massachusetts,  
Boston, MA  
Renee Wells, Cultural Access Consultant, Middlebury, VT

This book is based on the 1992 revision of **The Arts and 504**, which was originally commissioned and published in 1985 by the National Endowment for the Arts and produced by Barrier Free Environments, Inc. (Betsy Laslett, author and editor; Ronald L. Mace, AIA, architectural consultant; Leslie Young and Peggy Melin, designers).

## Civil Rights for People with Disabilities: Framing the Discussion *(continued)*

- 1973:** The Rehabilitation Act prohibits discrimination on the basis of disability in programs conducted by federal agencies, in federal employment and the employment practices of federal contractors. Most importantly, Section 504 forbids discrimination against people with disabilities in any activity or program that receives federal financial assistance. The Secretary of Health Education and Welfare (HEW) did not issue regulations implementing Section 504 until April 28, 1977.
- 1975:** The Education for All Handicapped Children Act (EAHC) establishes the right of children with disabilities to an integrated public school education. In 1990 it is amended and renamed the Individuals with Disabilities Act (IDEA).
- 1976:** The fight by disability rights activists for accessible transportation starts with the Transbus group and continues with the organization of American Disabled for Accessible Public Transit (ADAPT) in 1983.
- 1977:** Disability rights activists in 10 cities demonstrate and occupy the offices of the Department of Health Education and Welfare (HEW) to force issuance of regulations implementing Section 504 of the Rehabilitation Act. The demonstrations galvanize the disability community nationwide. On April 28, the regulations are signed.
- 1981:** The Disability Rights Education and Defense Fund (DREDF) and the Disability Rights Center respond to the threat to amend or revoke regulations implementing Section 504 and the EAHC with intensive lobbying and grassroots efforts. After three years, attempts to revoke or amend the regulations are dropped.
- 1984:** The Voting Accessibility for the Elderly and Handicapped Act mandates that polling places be accessible or that ways be found to enable elderly and people with disabilities to exercise their right to vote.
- 1988:** Deaf students at Gallaudet University, Washington, DC, shut down and occupy the campus demanding selection of a deaf president. The Board of Trustees capitulate and announce the University's first deaf president.
- 1989:** The Congress and Senate take up the reintroduced second draft of the Americans with Disabilities Act (ADA). Disability organizations across the country advocate on behalf of ADA.
- 1990:** Hundreds of people with disabilities come to the nation's capital in support of the ADA. ADAPT activists occupy the Capitol rotunda and are arrested.
- 1990:** Americans with disabilities gain their full civil rights in the Americans with Disabilities Act (ADA), which prohibits discrimination on the basis of disability in employment, state and local government, public accommodations, commercial facilities, transportation and telecommunications.



NATIONAL  
ENDOWMENT  
FOR THE ARTS



NATIONAL  
ENDOWMENT  
FOR THE  
HUMANITIES

National Assembly of  
State Arts Agencies

KNOWLEDGE ★ REPRESENTATION ★ COMMUNITY



The Kennedy Center